



Models : GT-650.2 GT-750.4
 GT-900.2 GT-950.4
 GT-1700.2 GT-1200.4
 GT-2000.2 GT-3200.4
 GT-3000.2

Owner's Manual

INTRODUCTION

Amplifiers provide high-performance sound reinforcement for your mobile audio equipment. Its versatility enables compatibility with optional Equalizers, Frequency Dividing Network Crossovers, and other audio processors in a customized system. The Multi-Mode bridging capabilities allow flexibility in hosting several different speaker configurations.

To achieve optimum performance, We suggest that your stereo components are installed by an authorized dealer. It is highly recommended that you read this Owners Manual before beginning installation.

FEATURES - 2Ch & 4Ch AMPLIFIER

- MOSFET POWER SUPPLY AMPLIFIER
 - DOUBLE SIDED EPOXY THROUGH HOLE PCB
 - GOLD PLATED BRASS SET SCREW TERMINALS
 - 2/4 CHANNEL INPUT SELECTOR SWITCH (4CH. ONLY)
 - 24dB/Oct. CROSSOVER
 - VARIABLE HIGH PASS CROSSOVER (30Hz-500Hz)
 - VARIABLE LOW PASS CROSSOVER (30Hz-500Hz)
 - VARIABLE SUBSONIC FILTER 10Hz - 100Hz
 - VARIABLE 0dB TO 18dB BASS BOOST AT 45Hz
 - HIGH / LOW LEVEL RCA INPUT
 - 5 WAY PROTECTIONS
 - DAISY CHAIN THROUGH OUTPUT RCA
 - POWER AND PROTECTION LEDS
 - 2 OHM STABLE CIRCUITS
 - SOFT START / MUTE CIRCUIT
 - TRIMODE OUTPUT CONFIGUATIONS
 - 2 WAY INSTALLATIONS
-

FEATURES - MONO AMPLIFIER

- MOSFET POWER SUPPLY AMPLIFIER
 - SILVER PLATED
 - 24dB/Oct. CROSSOVER
 - VARIABLE LOW PASS CROSSOVER (50Hz-250Hz)
 - VARIABLE SUBSONIC FILTER 15Hz - 45Hz
 - VARIABLE 0dB TO 12dB BASS BOOST AT45Hz
 - 5 WAY PROTECTIONS
 - DAISY CHAIN THROUGH OUTPUT RCA
 - POWER AND PROTECTION LED
 - 1 OHM STABLE CIRCUITS
 - SOFT START / MUTE CIRCUIT
-

WARNING

High powered audio systems in a vehicle are capable of generating "Live Concert" high levels of sound pressure. Continued exposure to excessively high volume sound levels may cause hearing loss or damage. Also, operation of a motor vehicle while listening to audio equipment at high volume levels may impair your ability to hear external sounds such as: horns, warning signals, or emergency vehicles, thus constituting to a potential traffic hazard.

PLANNING YOUR SYSTEM

Before beginning the installation, consider the following:

- If you plan to expand your system by adding other components sometime in the future, ensure adequate space is left, and cooling requirements are met.
- Should you use high or low level inputs?

Your Amplifier has been designed to accept either High-Level (speaker outputs from your radio) or Low-Level (Pre-Amp outputs from your radio) signal source.

If your radio/source is equipped with Pre-Amp outputs, it is possible to utilize them to drive the Amplifier and connecting (Amplifier) to the 2 rear speakers. Then, use the built-in power of your radio to drive the 2 front speakers.

NOTE:

Distortion level is considerably lower from Pre-Amp (Low Level) outputs than speaker (high level) outputs.

- Are your components matched? The peak power rating of your speakers must be equal or greater than the Amplifier's. They also must be 2 - 8 Ohms impedance. (This information is normally printed on the speaker magnet)
- Consider both the length of your leads, and routing when determining the mounting location. Pre-Amp input Jacks require a length (depending on location) of high quality shielded male to male RCA patch cord.

MOUNTING YOUR AMPLIFIER

The mounting position of your Amplifier will have a great effect on its ability to dissipate the heat generated during normal operation. It has an ample heat sink for heat dissipation, and also designed with a thermal shut-down protection circuit, making it reasonably tolerant of mounting variations. Any configuration which allows moving air to be directed over the cooling fins will improve heat dissipation dramatically. DO NOT enclose the amplifier in a small box or cover it so that air cannot flow around fins.

Temperatures in car trunks have been measured as high as 175°F (80°C) in the summer time. Since the thermal shut-down point for the Amplifier is 185°F (85°C), it is easy to see that it must be mounted for maximum cooling capability. To achieve maximum advantage of convection air flow in an enclosed trunk, mount the amplifier in a vertical position, on a vertical surface.

Cooling requirements are considerably relaxed when mounting inside the passenger compartment since the driver will not often allow temperatures to reach a critical point. Floor mounting under the seat is usually satisfactory as long as there is at least 1 inch (2cm) above the Amplifier's fins for ventilation.

- Select a suitable location that is convenient for mounting, is accessible for wiring, and has ample room for air circulation and cooling.
- Use the amplifier as a template to mark the mounting holes. Remove the Amplifier and drill 6 holes. USE EXTREME CAUTION, INSPECT UNDERNEATH SURFACE BEFORE DRILLING.
- Secure the Amplifier using the screws provided.

CONNECTING THE POWER

CAUTION

AS A PRECAUTION, IT IS ADVISABLE TO DISCONNECT THE VEHICLE'S BATTERY BEFORE MAKING CONNECTION TO THE +12 VOLT SUPPLY WIRING.

10 GAUGE (Thicker if planning for additional Amplifiers) wire is recommended for both the power and ground wires. 20 Gauge, for the remote turn-on wire. Both types available at most Mobile Audio Dealers or Installation Shops.

GROUND : To Vehicle Chassis

To avoid unwanted ignition noise caused by ground loops, it is essential that the Amplifier be grounded to a clean, bare, metal surface of the vehicle's chassis.

NOTE

GROUND WIRE SHOULD NOT BE EXTENDED MORE THAN 3 FT. (1 METER). USING THIS METHOD CAN CAUSE TURN ON AND TURN OFF TRANSIENTS (NOISE)

+12 Volt (Fused) Constant Power : To Battery (+)

Due to the power requirements of the Amplifier, this connection should be made directly to the positive (+) terminal of battery. For safety measures, install an in-line 50 Amp Fuse Holder (not included) as close to the battery positive (+) terminal as possible.

With an ampere rating not to exceed total value of fuses in amp.

Remote Turn-On Input : To Power Antenna output of Car Stereo

This Amplifier is turned "ON" remotely when the vehicle's stereo is turned "ON".

NOTE

IF YOUR RADIO DOES NOT HAVE A +12 VOLT OUTPUT LEAD WHEN THE RADIO IS TURNED ON, "RMT" TERMINAL ON THE AMPLIFIER CAN BE CONNECTED TO VEHICLE'S ACCESSORY CIRCUIT THAT IS LIVE WHEN THE KEY IS "ON".

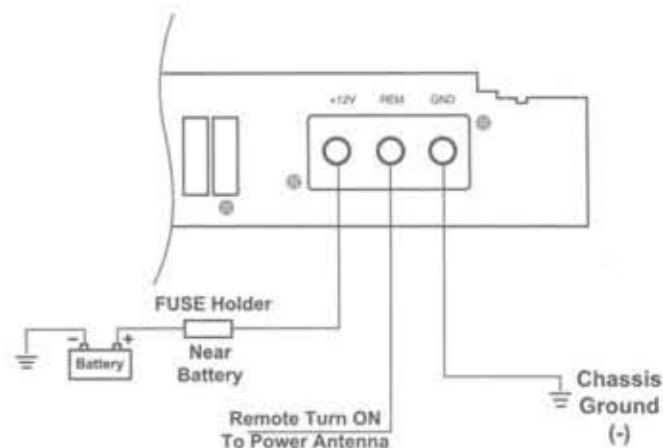

CONNECTING THE SPEAKERS

• 2CH Amplifier

a. Stereo Mode

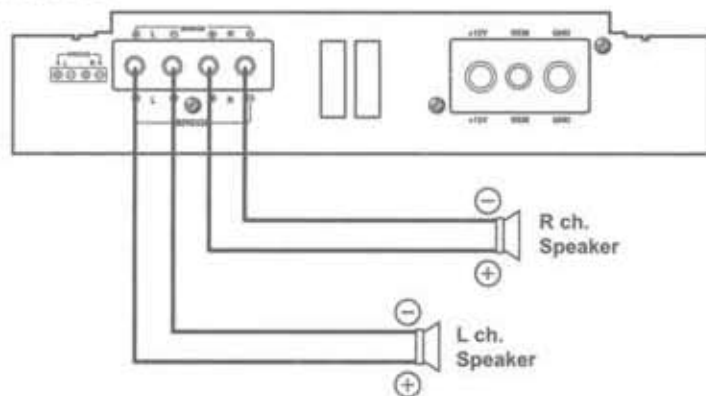

b. Mono Mode

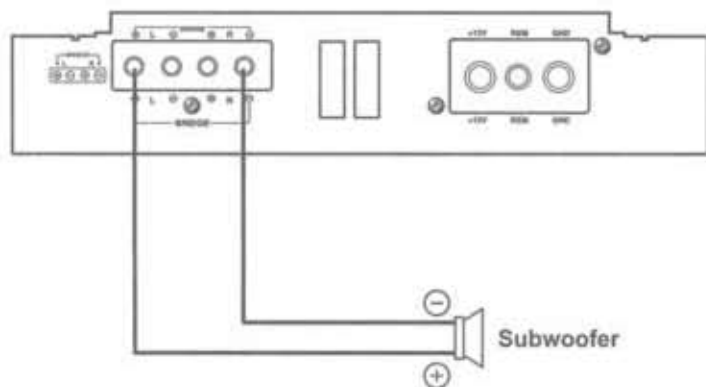

CONNECTING THE SPEAKERS

• 4CH Amplifier

a. 4CH Mode

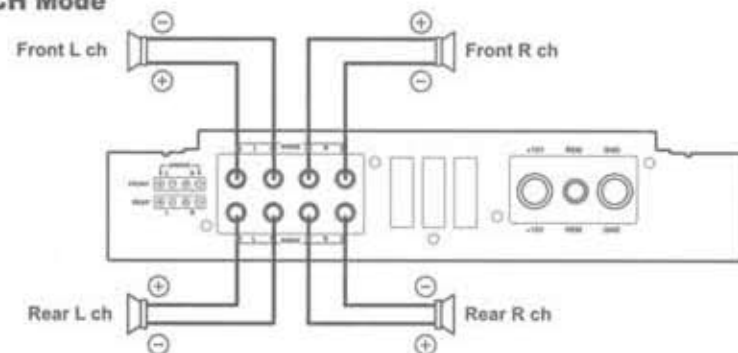

b. 3CH Mode

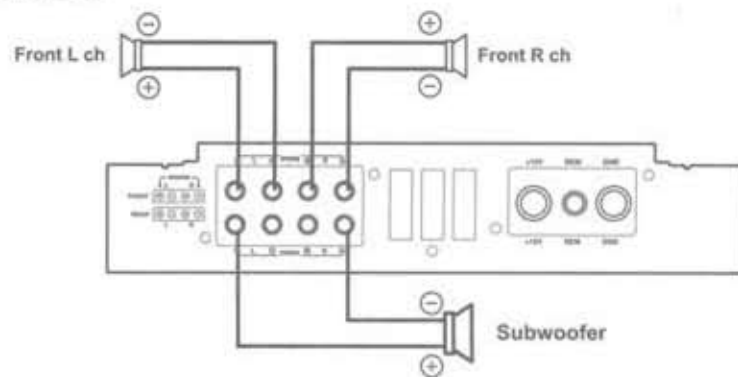

c. 2CH Mode

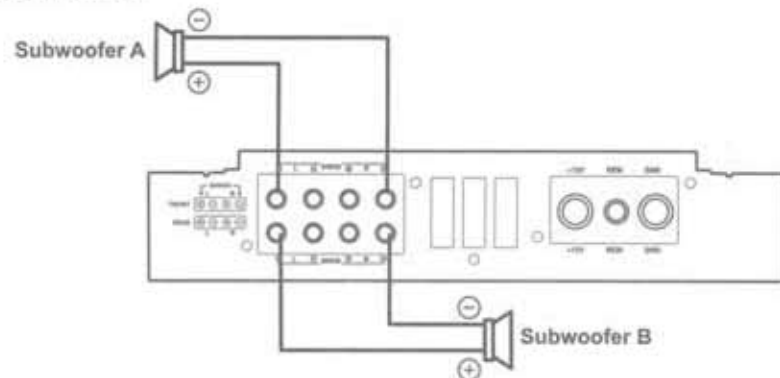

CONNECTING FOR PARALLEL OPERATION

4 Channel

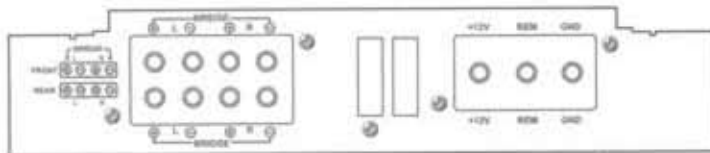
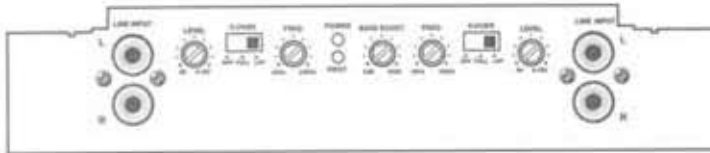
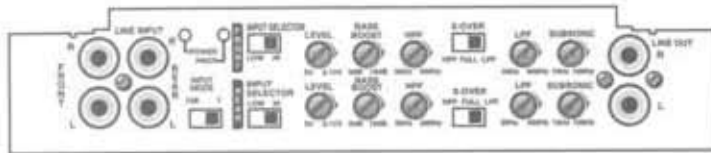

2 Channel

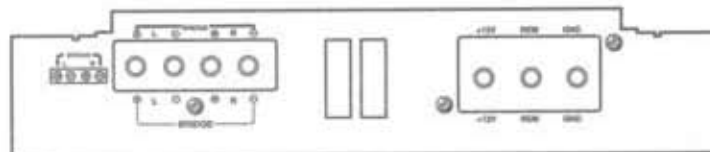
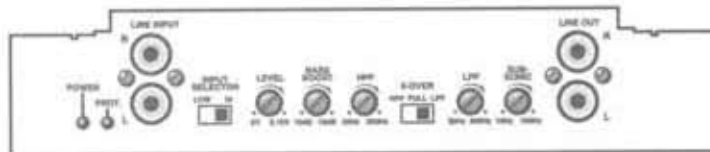

CONNECTING FOR PARALLEL OPERATION

- **RCA Low Level Input Jacks**
It allows left and right inputs to be connected to the amplifier using RCA plugs.
- **RCA Line Output Jacks**
Full range output from channel L&R inputs is provided at Line Out Jacks.
- **Input Select S/W**
It allows Low level input or High level input with this switch according to head unit source.
- **Input Level Control**
It allows for the adjustment of the gain of both channels to match the output level of the source. In addition, it allows for detailed adjustment with L&R level control to be separated.
- **Bass EQ**
Adjust the sub boost level of the selected frequency output from 0dB to 18dB.
- **Variable Highpass controls**
Adjust the crossover frequency of the High Pass output only, from 30Hz to 500Hz.
- **Amplifier X-over switch / Line outs X-over switch**
 - a) LPF : Allows for the control of the low pass frequency range (30Hz-500Hz) by using the Low Variable Control.
 - b) FULL : Allows for full range pass through.
 - c) HPF : Allows for the control of the high pass frequency range (30Hz-500Hz) by using the High Variable Control.
- **Variable Lowpass controls**
Adjust the crossover frequency of the LOW Pass output only, from 30Hz to 500Hz.
- **Subsonic Filter**
It admits of removing the frequency below 10Hz to 100Hz using the Subsonic Variable Control in order to protect subwoofer speaker or to produce powerful subwoofer sound.
- **Power LED**
It indicates when amplifier is on and no fault existence.
- **Protection LED**
It illuminates when fault condition exists, and amplifier immediately shuts down. If illuminated, turn amplifier off, check for shorted speaker leads and DC noise from RCA input and attempt to re-power amplifier. When amplifier overheats and thermal protection circuit shuts amplifier down, LED does not illuminate.
- **Input Mode Selector**
 - a) F&R : Allows for the Front & Rear input.
 - b) F : Allows for the Front Input only in case of using 2 channel input only.
- **Optional mounting**
In case of Vertical mounting you can use this optional installation way by using mounting brackets packed inside through side rail.
- **Speaker Terminal**
It allows the connection of speakers to the amplifier.
- **Fuse**
It protects both the amplifier and automobile electrical system from fault conditions.
- **Power connection**
Connects +12VDC power wire from the battery.
- **Remote connection**
Connects the control wire which allows the amplifier to be turned on and off by the radio cassette player.
- **Connects ground wire from a suitable ground point on the chassis.**

TROUBLESHOOTING

Before removing your Amplifier, refer to list below and follow suggested procedure. Speakers and their wires should be tested first.

No Output:

- Confirm that all terminal strip connections are firmly connected.
- Check in-line and built-in fuses. Both "+12V" and "REM" terminals must have +12 Volts to chassis ground.
- Confirm that signal source (Car Radio/Deck, EQ, X-over etc.) is connected and is supplying output signal.
To confirm that Amplifier is working, connect an RCA patch cord to LEFT & RIGHT low-Level inputs of Amplifier only (Do not connect the other end of the patch cord). Briefly tap the center pin of each (disconnected) RCA plug on the other (disconnected) end with your finger. This should produce a noise (feedback) in the speakers.

Only One Channel Works:

- Confirm that speaker terminal strip connections are firmly connected.
- Check "BALANCE" control on Car Stereo (or signal source) to verify it is at mid-point.
- If using RCA Low-Level inputs, reverse the input plugs at the Amplifier (right to left or vice versa).
If the channel that is silent reverses position, the problem is in the Car Stereo (EQ, X-over, or other signal source) or connecting cable.

Weak Output

- Check Input Sensitivity control adjustment.

Noise in Audio

- If noise is a "whine" that goes up and down with engine speed, confirm that Amplifier and any other source unit (Radio, EQ, X-over etc.) is properly grounded.
- A "clicking" or "popping" noise at a rate that follows engine speed is generally induced by the vehicle's ignition system.
Confirm that the vehicle is equipped with resistor plugs and plug wires. Or, ignition system may need service.
- Speaker and input wires should not be routed next to wires that interconnect lights and other accessories/equipment.
- If above steps do not improve/clear noise interference, the system should be checked by a professional mobile audio installer.

SPECIFICATIONS

SPEC. \ MODEL	GT-650.2	GT-900.2	GT-1700.2	GT-2000.2	GT-3000.2
POWER OUTPUT (DC 14.4V)					
RMS AT 4 Ohm, MONO	130W X 1Ch	150W X 1Ch	250W X 1Ch	600W X 1Ch	900W X 1Ch
RMS AT 4 Ohm, STEREO	50W X 2Ch	60W X 2Ch	120W X 2Ch	200W X 2Ch	300W X 2Ch
RMS AT 2 Ohm, STEREO	80W X 2Ch	100W X 2Ch	180W X 2Ch	300W X 2Ch	450W X 2Ch
MAX POWER	660W	900W	1700W	2000W	3000W
S/N RATIO	>100dB	>100dB	>100dB	>100dB	>100dB
THD (IHF-A)	0.02%	0.02%	0.02%	0.02%	0.02%
CHANNEL SEPARATION	>55dB	>55dB	>55dB	>55dB	>55dB
INPUT SENSITIVITY	0.15V-5V	0.15V-5V	0.15V-5V	0.15V-5V	0.15V-5V
INPUT IMPEDANCE	47KOhm	47KOhm	47KOhm	47KOhm	47KOhm
SLEW RATE	10V / Usec	10V / Usec	10V / Usec	10V / Usec	10V / Usec
DAMPING FACTOR	200 AT 4 Ohm	200 AT 4 Ohm	200 AT 4 Ohm	200 AT 4 Ohm	200 AT 4 Ohm
FUSE RATING	20A	25A	25A x 2	30A X 2	30A X 4
DIMENSIONS(inch)					
• WIDTH	8.7	8.7	8.7	8.7	8.7
• HEIGHT	2.2	2.2	2.2	2.2	2.2
• LENGTH	9.0	13.3	17.6	19.6	25.5

SPEC. \ MODEL	GT-750.4	GT-950.4	GT-1200.4	GT-3200.4
POWER OUTPUT (DC 14.4V)				
RMS AT 4 Ohm, MONO	150W X 2Ch	180W X 2Ch	300W X 2Ch	450W X 2Ch
RMS AT 4 Ohm, STEREO	50W X 4Ch	60W X 4Ch	100W X 4Ch	150W X 4Ch
RMS AT 2 Ohm, STEREO	75W X 4Ch	90W X 4Ch	150W X 4Ch	225W X 4Ch
MAX POWER	750W	950W	1200W	3200W
S/N RATIO	>100dB	>100dB	>100dB	>100dB
THD (IHF-A)	0.02%	0.02%	0.02%	0.02%
CHANNEL SEPARATION	>55dB	>55dB	>55dB	>55dB
INPUT SENSITIVITY	0.15V-5V	0.15V-5V	0.15V-5V	0.15V-5V
INPUT IMPEDANCE	47KOhm	47KOhm	47KOhm	47KOhm
SLEW RATE	10V / Usec	10V / Usec	10V / Usec	10V / Usec
DAMPING FACTOR	200 AT 4 Ohm	200 AT 4 Ohm	200 AT 4 Ohm	200 AT 4 Ohm
FUSE RATING	20A X 2	25A X 2	40A X 2	40A X 4
DIMENSIONS(inch)				
• WIDTH	8.7	8.7	8.7	8.7
• HEIGHT	2.2	2.2	2.2	2.2
• LENGTH	13.7	15.6	19.6	25.5