

LIMITED WARRANTY

DB DRIVE warrants any products purchased in the U.S.A. from an authorized DB DRIVE dealer. All products are warranted to be free from defects in material and workmanship under normal use and service for a period of (1) year when the unit installed by an authorized DB DRIVE dealer. Non-authorized dealer installed products carry a (1) year parts and labor limited warranty. This warranty applies to the original purchase only.

DB DRIVE will either repair or replace (as its option) any unit that has been found to be defective and under warranty provided the defect occurs within:

One (1) year if purchased through an authorized DB DRIVE dealer.

This limited warranty does not extend to units that have been subjected to misuse, abuse, neglect, or accident. Products that in DB DRIVE's judgment shows evidence of having been altered, modified, or serviced without DB DRIVE's authorization, will be ineligible under this warranty.

To obtain warranty service please contact your retailer or see our website www.dbdrive.net for more details.

All warranty claims must be handled directly through the authorized DB Research dealer they were originally purchased from



DB Research L.L.P.

302 Hanmore Industrial Parkway // Harlingen, TX 78550
ph: 877.787.0101 // fx: 956.421.4513 // www.dbdrive.net



NEO AMPLIFIERS

NEO 4v2

NEO 5v2

NEO 1.5Kv2

User Manual

• Installation Instructions / Owners Manual •

Due to continuous improvement of the product the Specifications are subject to change without notice.

INTRODUCTION

Congratulations on your purchase of a DB Drive state-of-the-art power amplifier. Your selection of a DB Drive car audio product indicates a true appreciation of fine musical reproduction. Whether adding to an existing system or including your DB Drive amplifier in a new system, you are certain to notice immediate performance benefits.

KEEP YOUR SALES RECEIPT

Take this time to attach your sales receipt to the manual and put in a safe place. In case of any unforeseen reason this product may need warranty service, your receipt will be necessary to establish purchase date.

RECOMMENDATION

A power amplifier's performance is only as good as its installation. Proper installation will maximize the system's overall performance. It is recommended that you have our product installed by an authorized DB Drive retailer. However, if you decide to install it yourself, please carefully read through this manual and take your time to do a quality installation.

Due to continuing product improvements and possible manual revisions, we recommend checking our website for latest product information at www.dbdrive.net.

IMPORTANT! Before making any connections, disconnect the car's battery until the installation is completed to avoid possible damage to the electrical system.

WARNING!

Exposure to high power sound system can cause hearing loss or damage. Listening to your system at loud levels while driving will impair your ability to hear traffic sounds and emergency vehicles. Use common sense when listening to your system.

Serial # _____

Model # _____



SAFETY PRECAUTIONS

Fuse amplifiers power wire at the battery

Be sure to fuse the power wire within 12" of the car's battery. This will protect the car's battery in case of a short circuit between the power amplifier and battery. **THIS IS A MUST**, the amplifier's built-in fuse will only protect the power amplifier not the car's battery!

Use high grade wire connectors

To ensure maximum power transfer and secure safe connections, it is recommended to use high grade barrier spades (for connection at amplifier) and terminal rings (for connection at battery).

Do not run any wires underneath vehicle

Exposed wires have a chance of being cut or damaged. It is best to run all wires through the vehicle under the carpet and/or side panels. This lends to a cleaner installation and less risk of damage.

Use caution when mounting amplifier

Remember there are many electrical wires, gas lines, vacuum lines, brake lines as well as a gas tank in the automobile. Make sure you know where they are when mounting the amplifier to avoid puncturing lines, shorting wires or drilling holes in the gas tank.

Run signal wires away from electrical wires

To avoid possibility of induced noise from the car's electrical system (i.e. popping noises or engine noise), run wires away from the car's electrical wiring.

Make all ground wires as short as possible and at the same point

In order to reduce the chance of ground loops (i.e. engine noise), make the grounding wire as short as possible to reduce the wire's resistance. Also, when using multiple components, make sure all units are grounded at the same point.

Avoid sharp edges when running the wires

To avoid the possibility of power, signal or speaker shorts, be careful not to allow the amplifiers wires to come in contact with sharp edges. Use a grommet to protect the wire when running through the fire wall.

FEATURES AND BENEFITS

DC Offset Protection

This circuit protects the output of the amplifier against DC voltage. If for some reason DC voltage is detected at the output stage, the amplifier will shut down protecting the speakers from direct current.

Short Circuit Protection

The circuit protects the amplifier from damage due to a short found in the speakers or wiring. If one of the speakers or its wiring comes in contact with ground, the amplifier will shut down. To resume normal operation, correct the problem and turn the head unit off, then back on. The amplifier will reset and play again.

Thermal Protection

To protect the amplifier circuitry against damage caused by prolonged exposure to high temperatures, a thermal protection circuit is activated if the amplifier reaches excessively high operating temperature. Once the thermal circuit is activated, the amplifier will shut down to cool off. The amplifier will automatically turn back on once it cools down to a safe operating temperature.

Power Indicator

The diagnostic L.E.D. illuminates when the amplifier is on and receiving power.

Built-in Crossover

The NEO amplifiers include a built-in variable crossovers. The crossover features a variable frequency selection for precise low pass filtering for the NEO1.5Kv2. The NEO4v2 and NEO5v2 also feature the same frequency selection with the option or high pass or low pass filtering.

Power and Speaker Distribution Blocks

Heavy gauge bare wire distribution blocks are provided for maximum power and signal transfer with minimal resistance.

Bass Boost (NEO1.5Kv2) (NEO5v2)

For added low frequency performance the amplifiers are equipped with a variable *0~12 dB bass boost @ 45Hz.

Power Fusing

This protects the amplifier against short circuits and excessive current.

NEO4v2 - 60 Amp

NEO5v2 - 70 Amp

NEO1.5Kv2 - 80 Amp

Remote Turn-on

Automatically turns amplifier on when connected to the head unit's remote output. The amplifier will turn on and off with the head unit to save current consumption. This control also operates the reset circuit for the amplifier's protection. It must be connected with the head unit in order to reset protection circuits.

Adjustable Input Sensitivity

Allows you to fine-tune the level matching between your source and the power amplifier.

Low Impedance Stability

NEO4v2 - 20hm Stereo

NEO5v2 - 20hm Stereo

NEO1.5Kv2 - 10hm Mono



MOUNTING LOCATION

Before you start the installation, it will be necessary to find a mounting location for the amplifier. Find a location in which the amplifier will receive adequate ventilation in order to dissipate the heat it develops during operation. Two popular mounting locations are in the trunk or under the seat.

Select the location in which you wish to mount the amplifier. Use caution when mounting amplifier, there are many wires, gas lines, vacuum lines, brake lines as well as a gas tank in the automobile. Make sure you know where they are when mounting the amplifier to avoid puncturing lines, shorting wires or drilling holes in the gas tank. Once you are ready, use a pencil to mark the mounting holes in the bottom panel. After you have marked the locations of the holes move amplifier out of the way and drill small starter holes to make the tapping screws easier to install. Use provided screws to tighten down the **amplifier**.

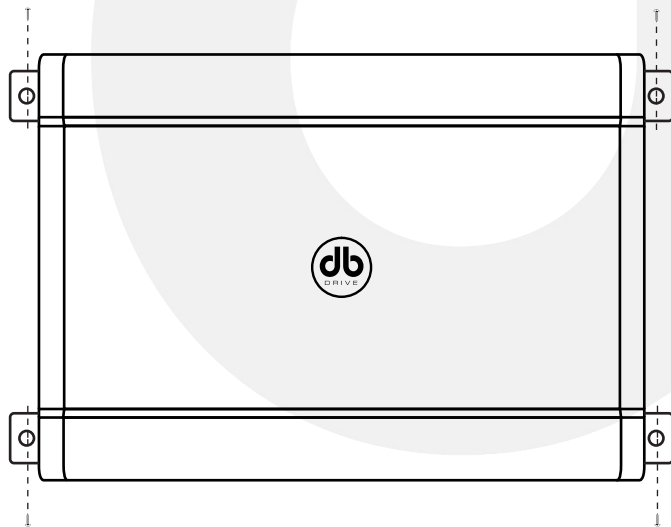

POWER CONNECTIONS

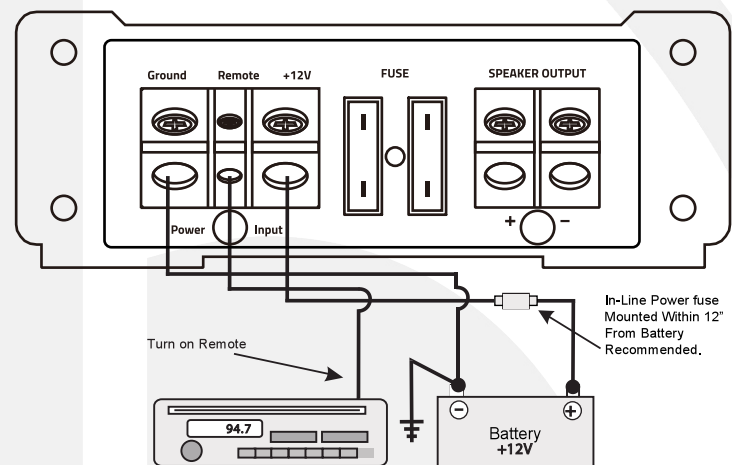

IMPORTANT! Before making any connections, disconnect the car's battery until the installation is completed to avoid possible damage to the electrical system.

Connect the amplifier to the car's battery

At times, the amplifier will need to draw large levels of current that cannot be provided by any circuit in the car's fuse box. We recommended using a 4 to 8 gauge power wire for your connections depending on the amplifier and length of the wire. Strip one end of the wire to connect to the terminal on the amplifier marked "batt+". Loosen screw terminal and connect bare wire and tighten. Use caution to make sure no stray wire strands come in contact with surrounding terminals causing short circuits. Run the wire directly to the positive terminal of the car's battery. Make sure to use an in-line fuse within 12" of the car's battery to protect the electrical system and amplifier against short circuits and/or power surges.

Connect the ground terminal of the amplifier to the car's chassis

For the ground connection, use a 4 to 8 gauge wire (black) to connect to the terminal marked "ground" and then connect it to the car's chassis. Try to keep the length of the cable as short as possible, preferably less than 6". Also make sure that the point on the car where the connection is to be made is free of paint and dirt.

Connect the remote terminal of the amplifier to a switchable +12V source

This connection allows the amplifier to be turned on and off with the power control of the radio. If the radio has a REMOTE output terminal, connect it to the amplifier's terminal marked "remote" (using a 16 gauge wire or heavier). Now when the radio is turned on, the amplifier will automatically turn on. This connection can also be made to the radio's Power Antenna wire.

SIGNAL CONNECTIONS

Connect the RCA output of the head unit (AM/FM cassette player, CD, or DAT) to the RCA input terminals of the amplifier.

To make these connections, we recommend high quality RCA cables, which are available at your local car audio retailer. Run signal wires away from electrical wires to avoid possibility of induced noise from the car's electrical system (i.e. popping noises or engine noise).

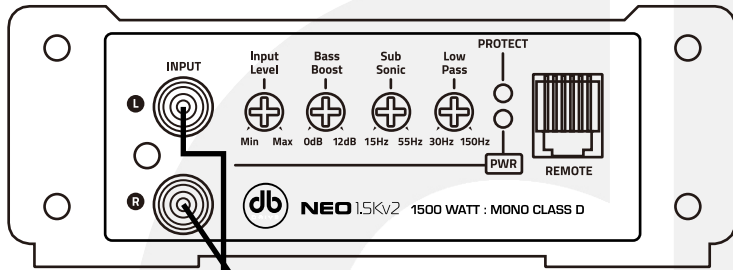

MONO SIGNAL CONNECTION

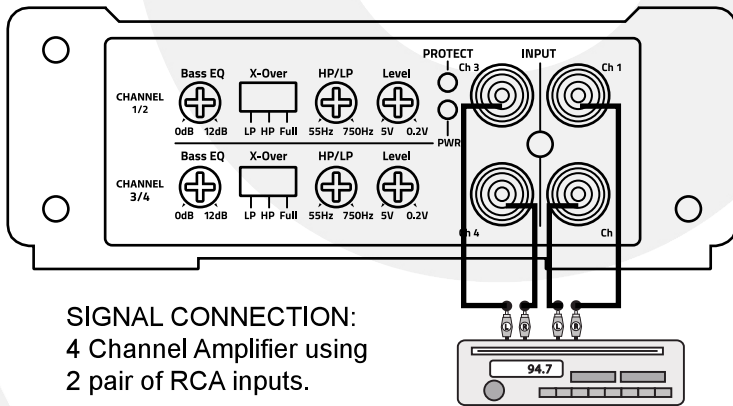

SIGNAL CONNECTION:
4 Channel Amplifier using
2 pair of RCA inputs.

SPEAKER CONNECTIONS

IMPORTANT! The following speaker connections are for the amplifier in normal mono configuration.

Make the speaker connections using speaker wire that is at least 16 gauge or heavier.

As with any audio component, proper phasing of the amplifier and speakers is essential for strong bass response. When connecting, make sure that positive (+) from the amplifier is connected to the positive (+) of the speaker, and the same for negative (-).

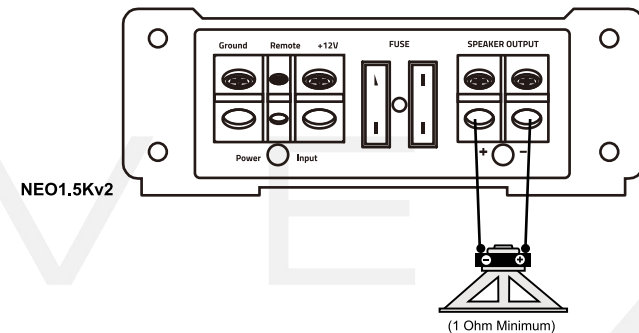
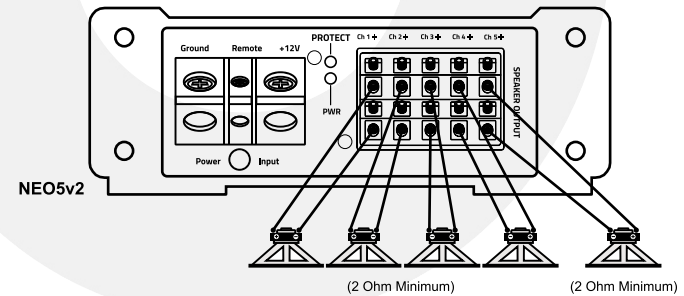
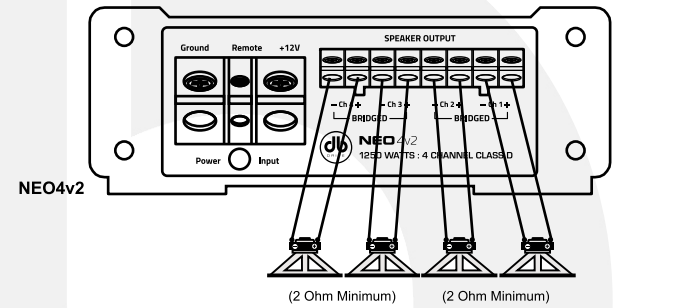

TROUBLE SHOOTING THE SYSTEM

We have put together this trouble-shooting guide if you experience problems after installing the amplifier. Please keep in mind that the majority of problems incurred are caused by improper installation and not the equipment itself. In addition, there are many components in the system that could cause various signal problems such as inducted electrical noise and engine noise.

Before you can properly address the problem, you must first find the component that is causing the problem. This will take patience and a process of elimination.

LOOK FOR.....	SOLUTION
No Output	
Blown fuse	Replace
Bad RCA Cable(s)	Replace
+12V at power terminal	Check connection
+12V at remote terminal	Check connection
Grounding point clean and tight	Check for ground w/meter
Head Unit's fader not in center position	Set to center position
Master & Slave settings	Confirm correct setting
Low Output	
Check level adjustments	
Re-adjust	
Bad RCA cable(s)	Replace
Improper level matching	Re-adjust
Master & Slave settings	Confirm correct setting
Engine Noise	
Grounding points are clean and tight	Check for ground w/meter
Ground all components at same point	Ground at same point
Try different grounding point	Change for better ground
Bad RCA cable(s)	Replace
Use High Quality shielded RCA cables	Rejects inducted noise
Low Vehicle charging system and/or battery	Fix and/or replace
Red Protection L.E.D. illuminated	
Speaker short	Check speakers connection for short circuit
Speaker grounding out	Make sure speaker wires Do not touch chassis ground
Impedance too low	Check speaker impedance
Overheating	Check mounting location for Adequate air circulation speaker impedance too low

SPECIFICATIONS

NEO4v2

4 CHANNEL CLASS D FULL RANGE AMPLIFIER

Load	Voltage	Output Power
4Ohm	14.4 Volts	4 x 125W
2 Ohm	14.4 Volts	4 x 250W
4 Ohm Bridged	Bridged	2 x 500W

THD (1kHz @ 4Ω):	0.04%
Bandwidth (-3 dB):	18Hz- 22KHz
Damping Factor (1k Hz @ 4Ω):	100
S/N ratio (as weighted @ 1 Volt):	99db
Input Sensitivity:	.20MV - 5.0V RMS
Minimum Load Impedance:	2Ω
Input :	Pre in RCA
Channel 1-2 filter range:	55Hz - 750Hz
Channel 3-4 filter range:	55Hz - 750Hz
Variable Bass Boost @45 Hz:	0 ~ 12dB

NEO5v2

5 CHANNEL CLASS D FULL RANGE AMPLIFIER

Load	Voltage	Output Power
4Ohm	14.4 Volts	4 x 125W
2 Ohm	14.4 Volts	4 x 250W
4 Ohm Bridged	Bridged	2 x 250W
2 Ohm 5 th CH	14.4 Volts	1 x 500W

THD (1kHz @ 4Ω):	0.04%
Bandwidth (-3 dB):	18Hz- 22KHz
Damping Factor (1k Hz @ 4Ω):	100
S/N ratio (as weighted @ 1 Volt):	99db
Input Sensitivity:	.20MV - 9.0V RMS
Minimum Load Impedance:	2Ω
Input :	Pre in RCA
Channel 1-2 High Pass Filter	40Hz - 300Hz
Channel 3-4 High Pass Filter	40Hz - 300Hz
Channel 5 LowPass Filter	40Hz - 400Hz
Variable Bass Boost @45 Hz:	0 ~ 12dB

NEO1.5Kv2

MONO CLASS D AMPLIFIER

Load	Voltage	Output Power
1 Ohm	14.4 Volts	1 x 750W
2 Ohm	14.4 Volts	1 x 350W

THD (1kHz @ 4Ω):	0.04%
Bandwidth (-3 dB):	18Hz- 22KHz
Damping Factor (1k Hz @ 4Ω):	100
S/N ratio (as weighted @ 1 Volt):	99db
Input Sensitivity:	.20MV - 5.0V RMS
Minimum Load Impedance:	2Ω

Input :	Pre in RCA
Mono Low Pass filter slope:	12dB
Low Pass filter range:	30Hz ~ 150Hz
Sub - Sonic Filter Slope:	12dB
Sub - Sonic Filter Range:	15Hz ~ 55Hz
Bass Boost @45 Hz:	0 ~ 12dB



NEO
AMPLIFIERS

