



WDX G2

SUBWOOFER MODELS

WDX6.5G2.2 / WDX6.5G2.4

WDX8G2.4

WDX10G2.4

WDX12G2.2 / WDX12G2.4

WDX15G2.2 / WDX15G2.4

USER MANUAL

Installation Instructions | Owners Manual

Introduction

Congratulations on your purchase of a DB Drive state-of-the-art subwoofer. Your selection of a DB Drive car audio product indicates a true appreciation of fine musical reproduction. Whether adding to an existing system or including your DB Drive subwoofer in a new system, you are certain to notice immediate performance benefits.

Product Commitment

DB's engineering professionals harnessed years of expertise, experience and passion, coupled with exhaustive testing and creative design to develop the optimal product and performance for your musical enjoyment. This is our commitment to you. It's what you deserve and have come to expect from DB DRIVE. We appreciate the confidence and look forward to your positive experience.

Keep Your Sales Receipt

Take this time to attach your sales receipt to the manual and put in a safe place. In case of any unforeseen reason this product may need warranty service, your receipt will be necessary to establish purchase date.

Recommendation

A power subwoofer's performance is only as good as its installation. Proper installation will maximize the system's overall performance. It is recommended that you have our product installed by an authorized DB Drive retailer. However, if you decide to install it yourself, please carefully read through this manual and take your time to do a quality installation.

Optimal Product Choice

To get the Maximum performance out of your stereo system, we recommend using 100% authentic DB Drive electronics and DB LINK wiring and accessories. Matching DB Drive amplifiers and Speakers with your state-of the art electronics purchase is critical to optimize your system's performance. Wiring is the lifeblood of a system, make sure your audio system has the adequate current and signal transfer it deserves and needs. DB Link has it all, from wiring rolls; Speaker, power, ground and remote to amplifier kits, RCAs, and Fuse holders, distribution blocks and battery connectors. Insist on getting the best, DB LINK. It's what you deserve to get the optimum performance from your audio System.

IMPORTANT!

Before making any connections, disconnect the car's battery until the installation is completed to avoid possible damage to the electrical system.

WARNING!

Exposure to high power sound system can cause hearing loss or damage. Listen in to your system at loud levels while driving will impair your ability to hear traffic sounds and emergency vehicles. Use common sense when listening to your system.

Serial # _____ Model # _____

PRODUCT FEATURES

- Protective magnet cover
- Large gauge compression terminals
- Rubber gasket trim ring
- Die-cast aluminum vented basket
- Dual poly-cotton dampeners
- Double stitched foam surround
- Non-Pressed paper cone
- High temperature voice coil

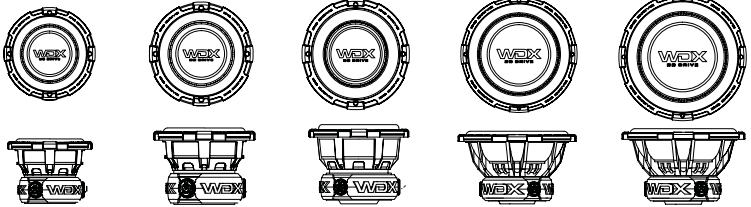

	WDX6.5G2.2 / WDX6.5G2.4	WDX8G2.4	WDX10G2.4	WDX12G2.2 / WDX12G2.4	WDX15G2.2 / WDX15G2.4
Structure:	6.5" (16.5cm)	8" (20.32cm)	10" (16.5cm)	12" (30.48cm)	15" (38.1cm)
Max Power:	1500 Watts	1500 Watts	2200 Watts	2500 Watts	2500 Watts
Nominal Power:	750 Watts	750 Watts	1100 Watts	1250 Watts	1250 Watts
Impedance:	2" (50.8mm) 2Ω Dual Voice Coil/ 4Ω Dual Voice Coil	2.5" (63.5mm) 4Ω Dual Voice Coil	3" (76.2 mm) 4Ω Dual Voice Coil	3" (76.2mm) 2Ω Dual Voice Coil/ 4Ω Dual Voice Coil	3" (76.2mm) 2Ω Dual Voice Coil/ 4Ω Dual Voice Coil

PRODUCT SPECIFICATIONS

T/S:	WDX6.5G2.2	WDX6.5G2.4	WDX8G2.4	WDX10G2.4	WDX12G2.2	WDX12G2.4	WDX15G2.2	WDX15G2.4
Fs:	49.167Hz	52.4Hz	45.5Hz	46.1Hz	43.6Hz	41.5Hz	37.4Hz	37.42Hz
Re:	2Ω x 2	3.2Ω x 2	3.2Ω x 2	3.2Ω x 2	2Ω x 2	3.2Ω x 2	2Ω x 2	3.2Ω x 2
Qms:	3.66	4.33	5.62	5.48	4.71	3.96	7.50	4.1
Qes:	0.795	0.71	0.49	0.62	0.55	0.55	0.65	0.55
Qts:	0.65	0.61	0.45	0.56	0.5	0.48	0.60	0.62
Vas:	3.68L	2.8L	4.3L	8.9L	19.3L	23L	52L	49.44L
Cms:	126.6 mm/N	0.10 mm/N	0.08 mm/N	0.06 mm/N	0.05 mm/N	0.06 mm/N	0.05 mm/N	0.05 mm/N
BL:	11.34 N/A	16.7 N/A	19.5 N/A	24.7 N/A	22.3 N/A	27.7 N/A	22 N/A	26.89 N/A
Mms:	82.76 gr	94.2 gr	162.5 gr	203.9 gr	252.4 gr	252.3 gr	336 gr	351.4 gr
SPL:	79.3dB	79.4dB	81.0dB	83.3dB	86.6dB	86.6dB	88dB	87.52dB
X-Max:	15mm	15mm	13mm	20mm	20mm	20mm	20mm	20mm

PRODUCT DIMENSIONS

- A** Frame Diameter
- B** Mounting Depth
- C** Cutout Diameter

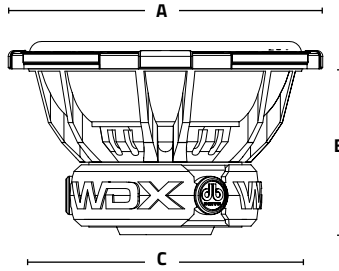

	WDX6.5G2.2 / WDX6.5G2.4	WDX8G2.4	WDX10G2.4	WDX12G2.2 / WDX12G2.4	WDX15G2.2 / WDX15G2.4
A Frame Diameter	7.20 in. (183 mm)	8.78 in. (223 mm)	10.98 in. (279 mm)	12.95 in. (329 mm)	15.71 in. (399 mm)
B Mounting Depth	5.18 in. (131.5 mm)	6.30 in. (160 mm)	7.09 in. (180 mm)	7.58 in. (192.5 mm)	8.48 in. (215.5 mm)
C Cutout Diameter	5.98 in. (152 mm)	7.32 in. (186 mm)	9.40 in. (239 mm)	11.34 in. (288 mm)	13.98 in. (355 mm)

RECOMMENDED ENCLOSURE

The purpose of the information below is to help you select the most appropriate type of enclosure for your application. We have selected the two most popular enclosure types and their performance benefits.

Sealed Enclosure (Air-Suspension design): Characteristically simpler to make, sealed enclosures usually are better at controlling the woofer's excursion and performance at lower frequencies. The added control allows for higher power handling or use of a bigger amplifier. The secret is to maintain a perfect seal. Using Glues and sealants at all seams is recommended to prevent leaks and integrity of the enclosure. The size or volume of the enclosure will directly affect the performance of the woofer. Smaller enclosures generally provide the desired bump to the frequency response curb and Greater SPL. Larger enclosures will provide a lower but flatter response for deeper bass. In general, the benefit to the sealed enclosure versus a ported enclosure is a smaller foot print, simpler build with higher power handling, a more linear flat response, superior sound quality and extended low frequency output.

Ported Enclosure (Bass-Reflex or Vented): A ported enclosure is simply a sealed enclosure with a port or vent added to the sealed design for the purpose of tuning the enclosure to higher output at the desired tuned frequency, typically 3db or higher. Another advantage of a ported enclosure is the reduction of cone motion for the speaker, thus distortion at higher power levels within the tuned frequency response of the port. A drawback is that building a ported enclosure is more complex than sealed. Having the wrong port or vent could result in poor sound, and the potential of damaging a woofer when played too loud or out of the tuning frequency. Thus we recommend not guessing, please follow the guidelines listed in this manual or go to a professional. In General, the benefit of a ported enclosure versus a sealed is higher volume output at the tuned frequency, stronger bass output with lower power input.

Construction: We recommend using 3/4" MDF (Medium Density Fiberboard) for the construction of an enclosure. It is critical for the side walls of the enclosure not to flex due to the pressure generated by the woofer, bracing might be required. The enclosure sides should be secured together with nails/screwed. We also recommend the use of glues and sealants to maintain the integrity of the enclosure and eliminate leaks.

RECOMMENDED ENCLOSURE

Sealed

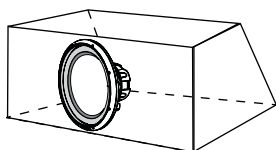

Vented

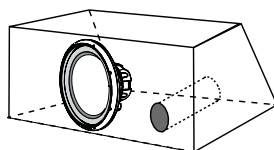

ENCLOSURES	WDX6.5G2.2 / WDX6.5G2.4	WDX8G2.4	WDX10G2.4	WDX12G2.2 / WDX12G2.4	WDX15G2.2 / WDX15G2.4
Woofer Cutout	5.98 in. (152 mm)	7.32 in. (186 mm)	9.40 in. (239 mm)	11.34 in. (288 mm)	13.98 in. (355 mm)
Mounting Depth	5.18 in. (131.5 mm)	6.30 in. (160 mm)	7.09 in. (180 mm)	7.58 in. (192.5 mm)	8.48 in. (215.5 mm)
Sealed Box	0.69 cuft. (19.53 L)	0.9 cuft (24.48 L)	1.38 cuft (39.07 L)	1.88 (53.23 L)	2.18 cuft (61.73 L)
Vented Box	0.88 cuft. (24.91 L)	1.13 cuft. (31.99 L)	1.77 cuft. (50.12 L)	2.6 cuft. (73.62 L)	3.17 cuft. (89.76 L)
• Vent Area	5 sq in. (32.25 cm ²)	10 sq in. (64.51 cm ²)	17 sq in. (109.67 cm ²)	20 sq in. (129.03 cm ²)	28 sq in. (180.64 cm ²)
• Vent Length	11 in. (27.94 cm)	22 in. (55.88 cm)	17 in. (43.18 cm)	17 in. (43.18 cm)	23 in. (58.42 cm)
• Tuning	36Hz	33Hz	33Hz	33Hz	33Hz
Dynamic Power	1500 Watts	1500 Watts	2200 Watts	2500 Watts	2500 Watts
Nominal Power	750 Watts	750 Watts	1100 Watts	1250 Watts	1250 Watts

CALCULATING ENCLOSURES

It is recommended to build your enclosure from 3/4" thick MDF (medium density fiberboard). Make sure the enclosure is sealed airtight.

Calculating External Volume: To calculate box volume, measure the outside Width x Height x Depth of the enclosure. *Example 12" x 14" x 9"=1512 ÷ 1728" Cubic feet.* Next you must convert cubic inches into cubic feet. To do this, you must divide the cubic inches total by 1728". *Example 1512 ÷ 1728=.875 Cubic feet*

Calculating Internal Volume: To calculate the internal (net) volume of the above box you must first multiply the thickness of the wood you are using by Two(2). *Example 3/4" x 2= 1.5"*

Next subtract 1.5 from each of the outside measurements of the box.

<i>Width</i>	<i>Height</i>	<i>Depth</i>
12 - 1.5 = 10.5	14 - 1.5 = 12.5	9 - 1.5 = 7.5

Multiple the new totals (**H x W x D**) *Example: 10.5 x 12.5 x 7.5 = .5696*

Next you must convert cubic inches into cubic feet. To do this, you must divide the cubic inch total by 1728". *Example 984.375 ÷ 1728=.5696 cubic feet.*

DVC WIRING CONFIGURATIONS

You can change the wiring configuration of your speakers (Series, Parallel and Series / Parallel) to match the impedance loads that maximizes the power output of you amplifier. Wiring the same woofer or multiple woofers in these three different wiring configurations will result in different impedance loads.

Series: Is the method of wiring of alternate positive with negative terminals (string method) (Illustration below)

Parallel: Is the method of wiring where you wire match 2 speaker terminals with positive to positive terminal and negative to negative. (Illustration below)

Series/Parallel: This configuration is a combination of both series and parallel. We recommend series for the terminal and parallel for the leads to amp. (Illustration below)

1 X 2Ω DVC SUBWOOFER

2Ω

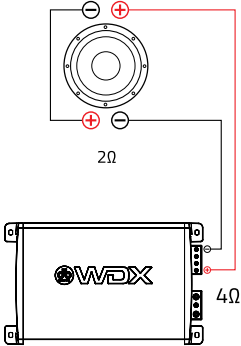

▪ SERIES ▪

1 X 2Ω DVC SUBWOOFER

2Ω

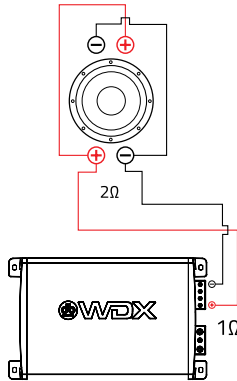

▪ PARALLEL ▪

2 X 4Ω DVC SUBWOOFER

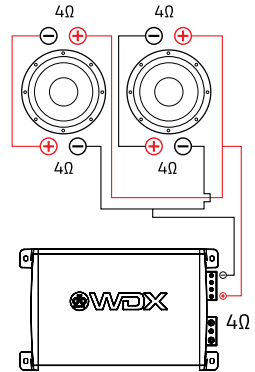

▪ SERIES/PARALLEL ▪

2Ω DVC WIRING CONFIGURATIONS

1 X 2Ω DVC SUBWOOFER

2Ω

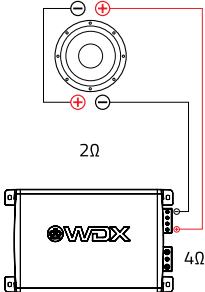

1 X 2Ω DVC SUBWOOFER

2Ω

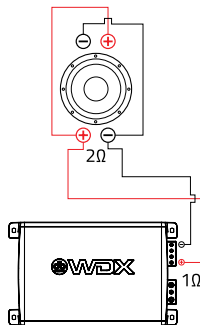

2 X 2Ω DVC SUBWOOFERS

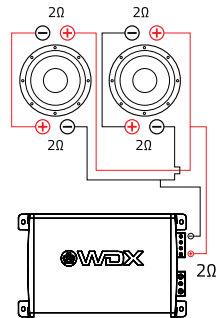

**3 X 2Ω DVC
SUBWOOFERS**

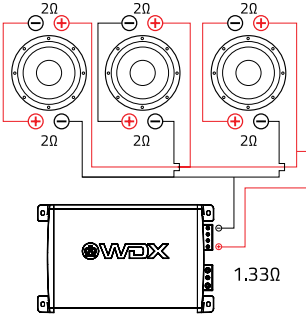

**4 X 2Ω DVC
SUBWOOFERS**

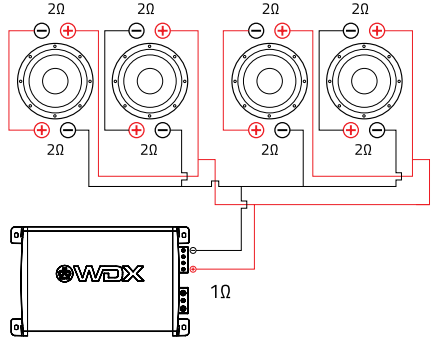

4Ω DVC WIRING CONFIGURATIONS

**1 X 4Ω DVC
SUBWOOFER**

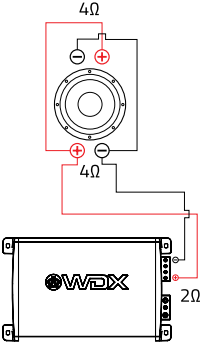

**2 X 4Ω DVC
SUBWOOFER**

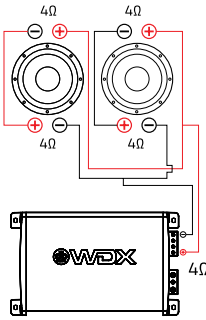

**2 X 4Ω DVC
SUBWOOFER**

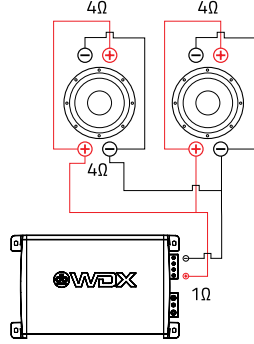

**3 X 4Ω DVC
SUBWOOFER**

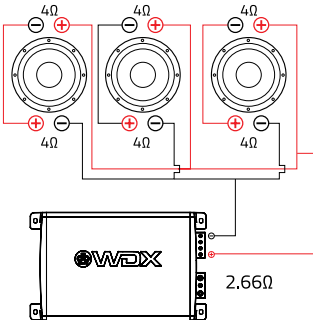

**4 X 4Ω DVC
SUBWOOFER**

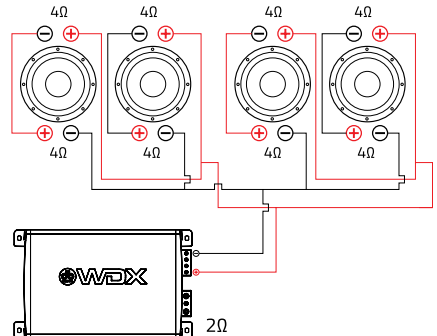

LIMITED WARRANTY

DB Drive™ warrants any products purchased in the U.S.A. from an authorized DB Drive™ dealer.

All products are warranted to be free from defects in material and workmanship under normal use and service for a period of one (1) year.

This warranty applies to the original purchase only.

DB Drive™ will either repair or replace (as its option) any unit that has been found to be defective and under warranty provided the defect occurs within the one (1) year warranty period.

This limited warranty does not extend to units have been subjected to misuse, abuse, neglect, or accident. In DB Drive™'s judgment, products that show evidence of having been altered, modified, or serviced without DB Drive™'s authorization, will be ineligible under this warranty.

To obtain warranty service please contact your retailer or visit our website at www.dbdrive.net for more details.



DB Research L.L.P. ■ 302 Hanmore Industrial Parkway ■ Harlingen, TX 78550
Ph: (877) 787-0101 ■ Fax: (956) 421-4513 ■ tech support: support@dbdrive.net

Designed and Engineered in the U.S.A. 