

# ETX-18SP Powered Subwoofer

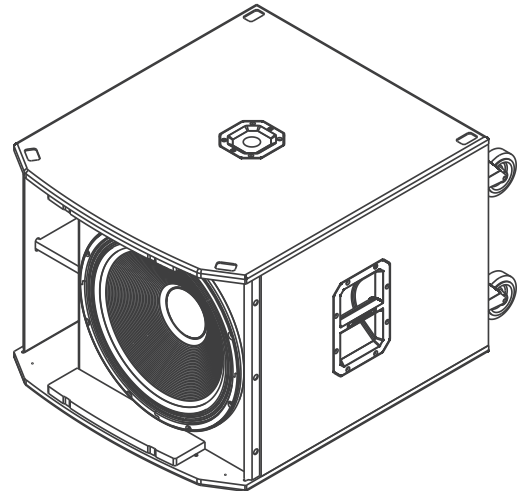

- 1800 W amplifier and 135 dB peak
- Single-knob DSP includes presets for multiple configurations and top+sub combinations (performance style, locations, and space)
- Loudspeaker system performance monitoring via integrated LCD and front panel LED
- Includes DSP preset for true cardioid performance
- Enclosure includes removable casters and a combo pole cup (insert and threaded) for use with the two-way models



ETX-18SP from Electro-Voice is a powered subwoofer; it can be used in a variety of portable and permanent applications. The DSP (Digital Signal Processing) menus offer extensive configurations, crossovers, true cardioid presets, protection limiters, EQ mode, and a lock out mode that prevents casual changes to the system. Loudspeaker system performance is optimized via an LCD screen. The front LED indicates power or can be configured to indicate limit.

EV's FIR-Drive technology utilized the latest FIR (Finite Impulse Response) filter technology to optimize transducer linearity and advanced limiter algorithms for independent peak and thermal transducer protection. True cardioid DSP preset delivers true cardioid response across all frequencies.

The enclosure is constructed out of 18-mm plywood finished with EVCoat. Subwoofers include professional-grade castors, and combination pole mount receptacle for threaded and unthreaded loudspeaker poles.

ETX Powered Loudspeakers combine EV-engineered intelligent DSP, high-powered amplifiers and high-efficiency transducers to deliver that legendary EV sound and performance.

## System overview

### Subwoofer amplifier panel:

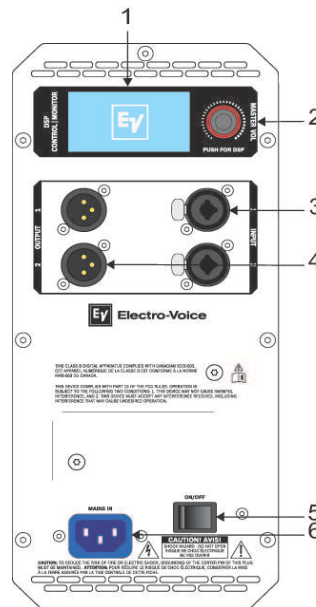

1. LCD
2. MASTER VOL/DSP
3. INPUT
4. OUTPUT
5. POWER
6. MAINS IN

## Technical specifications

<b>Frequency response (-3 dB): 33 Hz - 150 Hz<sup>1</sup></b>
Frequency range (-10 dB): 28 Hz - 180 Hz <sup>1</sup>
Maximum SPL: 135 dB peak <sup>2</sup>
Power rating: 1800 W
LF transducer: DVX3180A 457 mm (18 in)
Low pass frequency: Adjustable: 80 Hz, 100 Hz, 120 Hz, 150 Hz
Connectors: (2) XLR/TRS Combo Jack and (2) XLR link Output
Enclosure: 18 mm plywood with EVCoat
Grille: 16AWG steel with powdercoat
Color: Black
Dimensions (H x W x D): 550 mm x 675 mm x 910 mm (22 in x 27 in x 36 in)
Dimensions (H x W x D) without casters: 550 mm x 675 mm x 777 mm (22 in x 27 in x 31 in)
Net weight: 51.8 kg (114.2 lb)
Shipping weight: 58.9 kg (129.9 lb)

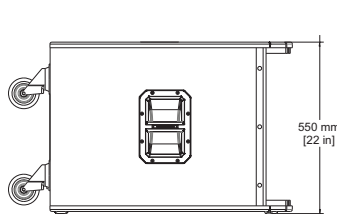

Left View

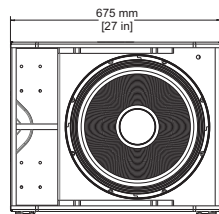

Front View

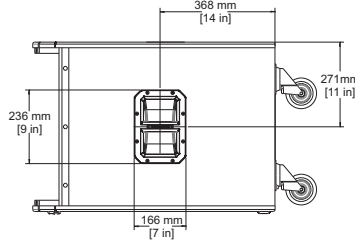

Right View

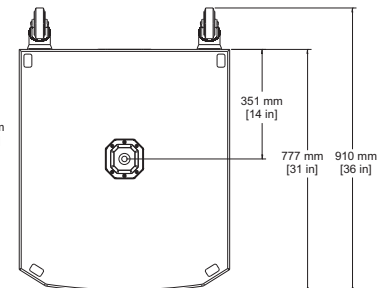

Top View

## Ordering information

### ETX-18SP-US ETX-18SP POWERED SUBWOOFER, BLK, US

18-inch powered subwoofer, black, US 120V  
Order number **ETX-18SP-US | F.01U.289.240**

### ETX-18SP-EU 18" powered subwoofer, EU cord

18-inch powered subwoofer, black, EU 240V  
Order number **ETX-18SP-EU | F.01U.289.241**  
**F.01U.396.745**

### Accessories

#### ETX-18SP-CVR Padded cover for ETX-18SP, EV logo

Padded cover for ETX-18SP, EV logo  
Order number **ETX-18SP-CVR | F.01U.297.639**

**Frequency response (-3 dB): 33 Hz - 150 Hz<sup>1</sup>**

Power consumption: 100 - 240 V~, 50 - 60 Hz, 1.6 - 0.8 A<sup>3</sup>

<sup>1</sup>Half space measurement using the music DSP preset and 150 Hz low pass.

<sup>2</sup>Maximum SPL is measured at 1 m using broadband pink noise at maximum amplifier output.

<sup>3</sup>Current rating is 1/8 power.

### Frequency response:

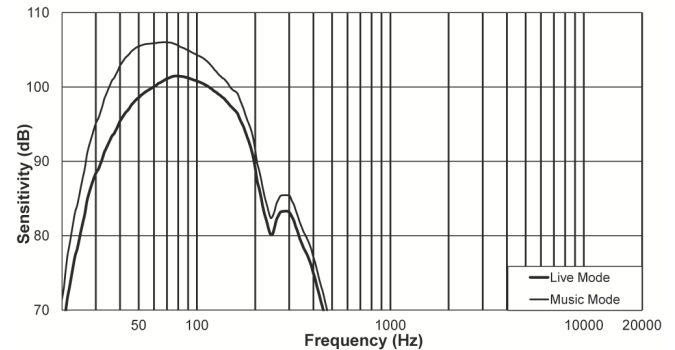

### Dimension drawing:

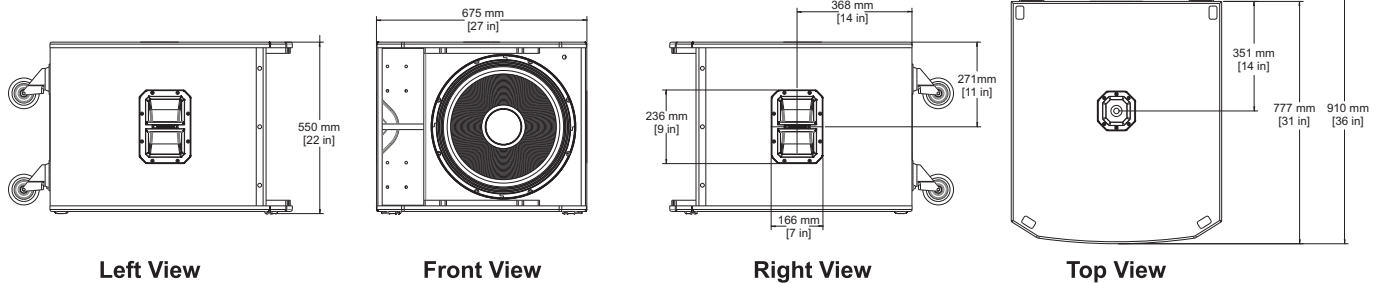

### Represented by:

**Germany:**  
Bosch Sicherheitssysteme GmbH  
Robert-Bosch-Ring 5  
85630 Grasbrunn  
Germany  
www.electrovoice.com

Bosch Security Systems, LLC  
12000 Portland Avenue South  
Burnsville MN 55337  
USA