

FUF17SMR

GE® 17.3 Cu. Ft. Capacity Frost-Free Upright Freezer

DIMENSIONS AND INSTALLATION INFORMATION (IN INCHES)

| AIR CLEARANCE | |
|-----------------|---|
| Each side (in.) | 3 |
| Top (in.) | 3 |
| Back (in.) | 3 |

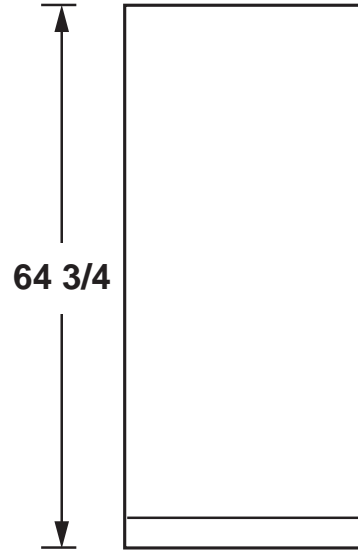

Front View

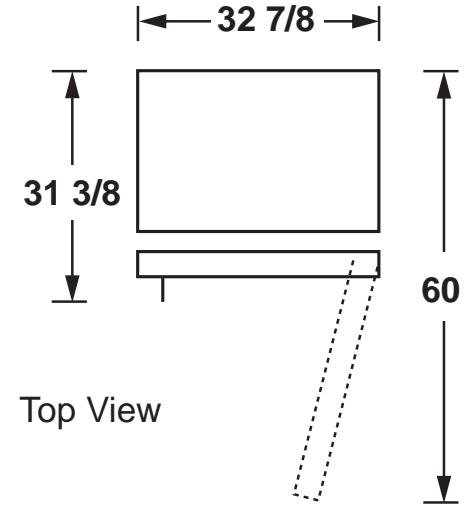

Top View



For answers to your Monogram, GE Café™ Series, GE Profile™ Series or GE Appliances product questions, visit our website at geappliances.com or call GE Answer Center® Service, 800.626.2000.



Specification Created 2/18

FUF17SMR

GE® 17.3 Cu. Ft. Capacity Frost-Free Upright Freezer

FEATURES AND BENEFITS

Garage ready – GE freezers are proven to perform at room temperatures ranging between 0° - 110F°

Audible temperature alarm – Alerts you if the door is left open or if the temperature rises

Exterior electronic temperature control – Easy adjust the temperature and avoid releasing cold air by opening the door

Turbo Freeze – An extra boost of cold air restores interior to set temperature for optimum food freshness

LED interior lighting – Automatically illuminates when door is open

Lock with key - Allows you to protect your valuable food items from unintentional entry

Model FUF17SMRWW – White

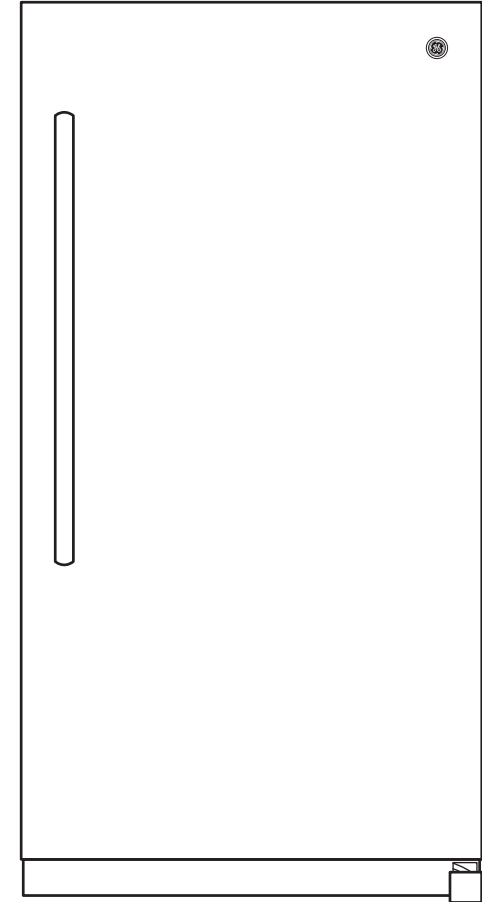

For answers to your Monogram, GE Café™ Series, GE Profile™ Series or GE Appliances product questions, visit our website at geappliances.com or call GE Answer Center® Service, 800.626.2000.



Specification Created 2/18