

**Communicating with the Access Network**

**Local Connecting with AccessBase2000**

After opening the AccessBase2000 application, go to the network settings screen and set each active network to connect using the virtual COM port number (COM2 - COM8) that was setup to communicate with its LIN-501C module.

**Local Connecting with AXNET**

Create a Windows direct connect network when setting up for AXNET communications. Be sure to select the virtual COM port number assigned to the LIN-501C module for the "Communications Cable Between Two Computers" setting. Be sure to configure the port speed to 38400 bps.

**Remote Connecting with AccessBase2000**

After opening the AccessBase2000 application, go to the network settings screen and set each active network to connect using the virtual COM port number (COM2 - COM8) that was setup to communicate with the router's external IP address and module's public port number.

✓ **NOTE: In existing installations, it is not recommended to connect with AccessBase2000 remotely on a separate setup PC. The installation's database in the local PC could get overwritten, causing LOSS OF ALL CARDHOLDER DATA and other programming! Always backup installation data!**

**Remote Connecting with AXNET**

Create a Windows direct connect network when setting up for AXNET communications. Be sure to select the virtual COM port number that was setup to communicate with the router's external IP address and module's public port number. Be sure to configure the port speed to 38400 bps. After the network connection is made and connected, use an Internet Web browser to connect to the AXNET panel.

**LIN-501C General Specifications**

✓ **Note: LIN-501C Module is only available in the AM-SEK Kit and is not sold separately.**

**Power:** 12 VDC from plug-in power supply (included), also supports a 5 volt DC redundant input from an external power supply

**Network Connection:** 100BASE-T RJ-45 connector

**Network Speed:** Fast Ethernet 10/100 Mbps

**Serial Connection:** Male DB9 for connection with A2C/DB9 serial cable (included)

**Serial Port Speed:** 38.4 Kbps

**Mounting:** DIN-rail or screw mounting

**Dimensions (LIN-501C Module):** 3-1/2" W x 3-3/4" H x 1" D

**Weight:** 6-1/2 ozs.

**Using Ping to Test IP Addresses**

1. From the Windows **START** menu, select **RUN**.
2. Enter **COMMAND** (or **CMD**) into the **OPEN:** field and press OK. The DOS command prompt window will open.
3. To test an IP address enter **PING** and the IP address.
4. If the Ping command displays "Request timed out." the IP address is not currently used. The address **can be assigned** to a LIN-501C module.

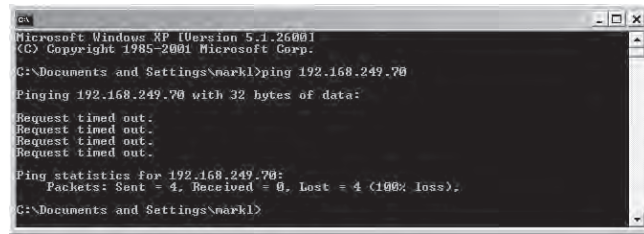

5. If the Ping command displays replies from the IP address, the address is already being used by a device and **cannot be assigned** to a LIN-501C module.

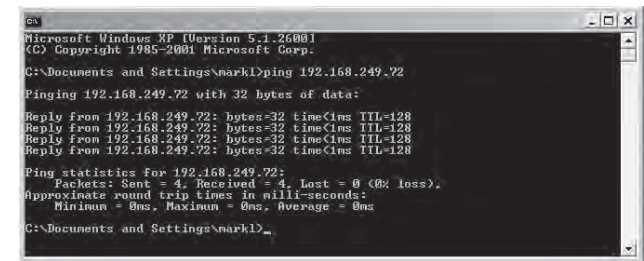

USA & Canada (800) 421-1587 & (800) 392-0123  
(760) 438-7000 - Toll Free FAX (800) 468-1340  
www.linearcorp.com

**Overview**

The AM-SEK Kit includes a LIN-501C Serial-to-Ethernet Module that provides a standard network TCP/IP connection for Linear's AM3Plus, AE1000Plus, and AE2000Plus access controllers. The module can be used as an alternative to a traditional telephone modem typically used for remote access to Plus panel controllers.

The LIN-501C module connects between the Plus panel's RS-232 Serial port and the installation's Local Area Network (LAN). Access to the panel can be locally through the LAN or remotely from the Wide Area Network (WAN). Typically the module is connected to a port on a router located on the installation's LAN.

**In Plus panel networks, with multiple panels interconnected via RS-485 wiring, the LN-501C module connects to Node #1 of an AXNET network, or Node #1 of any AccessBase2000 network.**

The LIN-501C does not replace the RS-485 and modem connections in a multiple access panel network. It does enable using an Ethernet network connection (instead of a direct serial connection or modem) between a Windows PC and supported Linear access panels to access and configure the panels using AXNET and/or AccessBase2000 applications.

For easy configuration and setup, Windows® based software utilities are included on the installation CD. The utility software is used for setting up the LIN-501C module's IP address and the computer's virtual COM ports. The utility software is compatible with Windows XP®, Windows Vista®, and Windows 7®. **To help with the module and router network configuration, a log sheet is provided to document the installation settings.**

**Network Issues**

Computer network topologies range from simple to complex. These instructions outline installation for a basic local area network. Large and complex networks may require setup that is beyond the scope of these instructions. If setup issues arise while configuring the LIN-501C module, seek assistance from the IT professional responsible for maintaining the network.

**Programming PC Overview**

At the installation site, a programming PC needs to be connected to the Local Area Network. This PC can be a permanent one in the installation, or can be a temporary PC brought in by the installer.

Administrator access will be required to setup the virtual COM ports on the PC. The virtual COM ports are assigned the IP address and port number of each LIN-501C module.

If AccessBase2000 is used to manage the access network, it needs to be installed on the management PC. **To avoid overwriting the installation's database, don't run AccessBase2000 remotely on a separate setup PC.**

If AXNET is going to be used to manage the access network, the PC will use a Windows direct connect network connection to communicate with the access network. Refer to Page 5 of AXNET manual P/N 226505 for details on setting up the Windows direct connect network connection.

**Module Installation**

1. Mount the LIN-501C module in a secure and weather protected location.
2. Connect the modular jack end of the A2C-DB9 cable to the RS-232 Port of the Linear "Plus" panel.
3. Connect the DB9 connector end of the A2C-DB9 cable to the COM port on the LIN-501C module.
4. Connect a CAT-5 network cable between the LAN connector on the LIN-501C module and an open port on the Local Area Network's router (300 foot cable length maximum).
5. Route the wire from the power supply and connect the power supply cable RED (+) and BLACK (-) terminals on the plug-in terminal block. Plug the terminal block into the module.
6. Repeat Steps 1-5 for each additional LIN-501C module installed for different access networks in the installation.
7. When power is applied, a module's RUN indicator should light and the LAN indicator should flash.

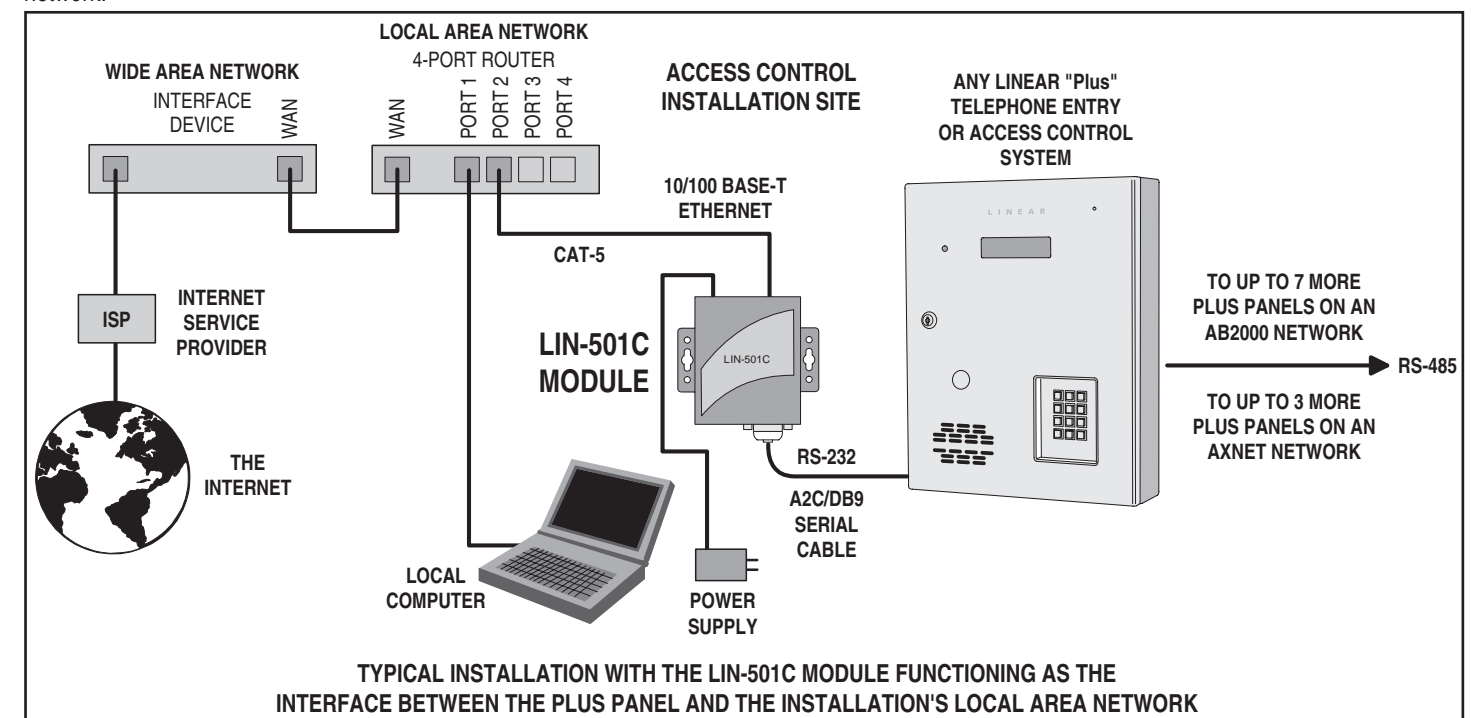

TYPICAL INSTALLATION WITH THE LIN-501C MODULE FUNCTIONING AS THE INTERFACE BETWEEN THE PLUS PANEL AND THE INSTALLATION'S LOCAL AREA NETWORK



**General LIN-501C Module Configuration**

1. From the Windows **START** menu, select **RUN**.
2. Enter **COMMAND** (or **CMD**) into the **OPEN:** field and press OK. The DOS command prompt window will open.
3. Enter **IPCONFIG** and press **ENTER**. The current Windows IP configuration for the PC will be displayed. Write down the IP Address, Subnet Mask, and Default Gateway address numbers. Keep the window open for reference or enter **EXIT** to close it.

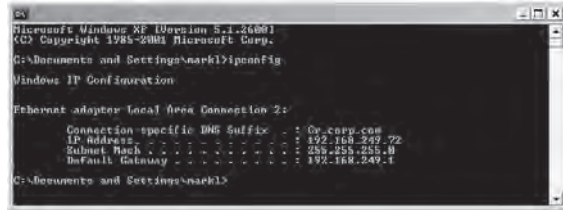

4. Insert the utilities CD into the PC's CD-ROM drive and launch the **monitor.exe** application. (For convenience, the files can also be copied from the CD to the programming PC and run from there.)
- ✓ **NOTE: The monitor.exe application has several buttons and options that are not used for LIN-501C module setup.**
5. Press the **INVITE** button. The application will display a list of all the LIN-501C modules discovered on the network.



- ✓ **NOTE: The monitor.exe application can only detect modules located on the LAN side of the same router as the PC.**
6. From the displayed list, select the IP address of the module to program. (To help to identify modules, checking the **LOCATE** box will cause the selected module to beep.) Press **CONFIG**.
7. The configuration for the selected module displays showing the fixed MAC address and currently programmed IP, Gateway, and Subnet Mask addresses.
8. A static IP address is required for the LIN-501C module. Verify that the **AUTO IP** box is un-checked.

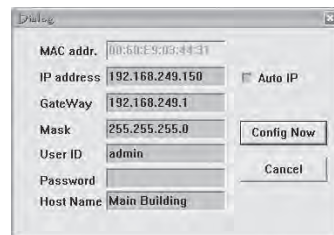

9. To allow the module to communicate with the PC on the same network, the first three octets (xxx.xxx.xxx) of the LIN-501C module's IP address must be set to the same as the programming PC's IP address. Set the first three octets for the module's addresses into the **IP ADDRESS** field. To avoid conflicts with existing network devices, choose a high number from 150-254 for the fourth octet. Example: PC = 192.168.242.72 Module = 192.168.242.150
- ✓ **NOTE: The IP address for each LIN-501C module in an installation must be unique and not conflict with other devices on the network. The DOS PING command can be used to check if an IP address is currently used or vacant (see Page 4).**
10. Set the Gateway and Subnet Mask addresses to the same as the programming PC.

11. Write the settings in the log sheet to document the access network module and note the modules address settings.
12. Enter a name for **HOST NAME** to identify the module or the access network installation.
13. Press **CONFIG NOW** to send the configuration to the module.
14. The LIN-501C module should beep and an acknowledge window will display. Press **OK**.

**PC Virtual COM Port Configuration**

1. Launch the **Vcom488.exe** installation program from the utility CD. Install the virtual COM port program on to the PC as instructed by the installation wizard.
2. Select the virtual COM port(s) that will be used to connect to the LIN-501C module(s). Press **OK**
- ✓ **NOTE: Serial-IP supports virtual COM ports 2-4096. AXNET can connect through any valid COM port. AccessBase2000 can only use ports 2-8. Each module in the installation will need a unique COM port assigned to the module's IP address.**

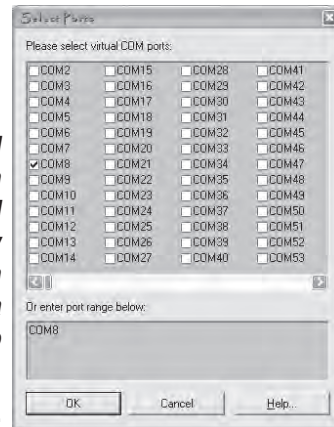

3. In the **SERIAL/IP CONTROL PANEL** select a COM port to use to connect to a module. Be sure the **CONNECT TO SERVER** box is checked. Enter the module's IP address in the **IP ADDRESS** field. Enter port 4660 into the **PORT NUMBER** field.
4. Press **CONFIGURATION WIZARD**. The Configuration window will be displayed. To test the PC's COM port serial-to-IP connection, press **START**.
5. The status area will show the progress of the test. Green check marks indicate that the connection is OK. Red check marks indicate failures in the test. If the test fails, verify the address and port settings of both the module and the PC. Be sure the first three octets of the LIN-501C module's IP address match the PC. Press **USE SETTINGS** to exit the wizard.

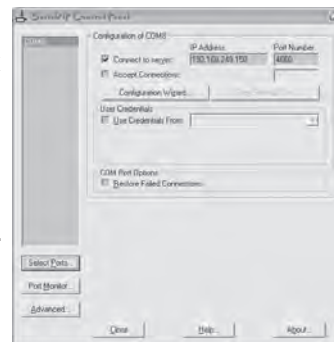

6. Repeat Steps 2 through 5 for any additional LIN-501C modules in the installation.
7. When finished, press **CLOSE** to exit the **SERIAL/IP CONTROL PANEL**. (The SERIAL-IP control panel can be restarted at any time from the Windows **START** menu.)



**Setup for Remote Off-Site Access**

The LIN-501C module installation and programming is identical for remote off-site access, the difference is in the router programming and the IP address used to communicate with the access network.

- ✓ **NOTE: For remote access, the LIN-501C module(s) must be connected to a router that supports a virtual server and has a STATIC external IP address. An Ethernet switch cannot be used.**

To be able to reliably connect with the router remotely over time, the router's external IP address must be a static IP. A dynamic IP address will change over time, which would require changing the virtual COM port setting each session before connecting.

**Router Setup**

Each LIN-501C module will have a unique IP address and will use private port number 4660. It's the "port forwarding" or "virtual server" in the router that will resolve a public port number to each module's IP address and private port number.

When connecting remotely to a module through the router's virtual server, the router's external IP address and module's public port number are used.

Example address: 71.167.14.130:4001

- 71.167.14.130 is the router's external IP address
- 4001 is the module's public port number

- ✓ **NOTE: Although similar, each manufacturer's router model's setup screens are different. The "virtual server" may be called another name depending on manufacturer. Some routers do not support public to private port forwarding through a "virtual server".**

The router will need to be setup on-site from a PC connected to the Local Area Network. Following is a typical router setup procedure:

1. On a PC connected to the router, open a browser window.
2. Enter the **internal** IP address of the router in the address bar of the browser. The router's login screen should be displayed.
3. Enter the username and password. Unless the router login has been reprogrammed, the typical default username is **admin**, and the password is **blank**. Click the **OK** to log into the router.

- ✓ **NOTE: If you cannot login to the router successfully, consult with the IT personnel at the installation for assistance.**

4. Virtual server or port forwarding is usually in the Advanced area of the router setup. Refer to the router manufacturer's documentation.
5. For each LIN-501C module connected to the router, enter the module's **IP address**, the module's **private port number** (always 4660) and an unused unique **public port number**. Be sure to setup and enable a virtual server for each module connected.

- ✓ **NOTE: Each public port number chosen for modules must be unique and currently available (unused).**

6. For "traffic type" select TCP, for "schedule" select always. Terms will vary per router model.
7. Each connection may also be able to be given a name. Enter a descriptive name for the location of each LIN-501C module. This will help to identify the module's router settings to yourself or others in the future.
8. After setting up the router, be sure to select **SAVE SETTINGS** in the router.

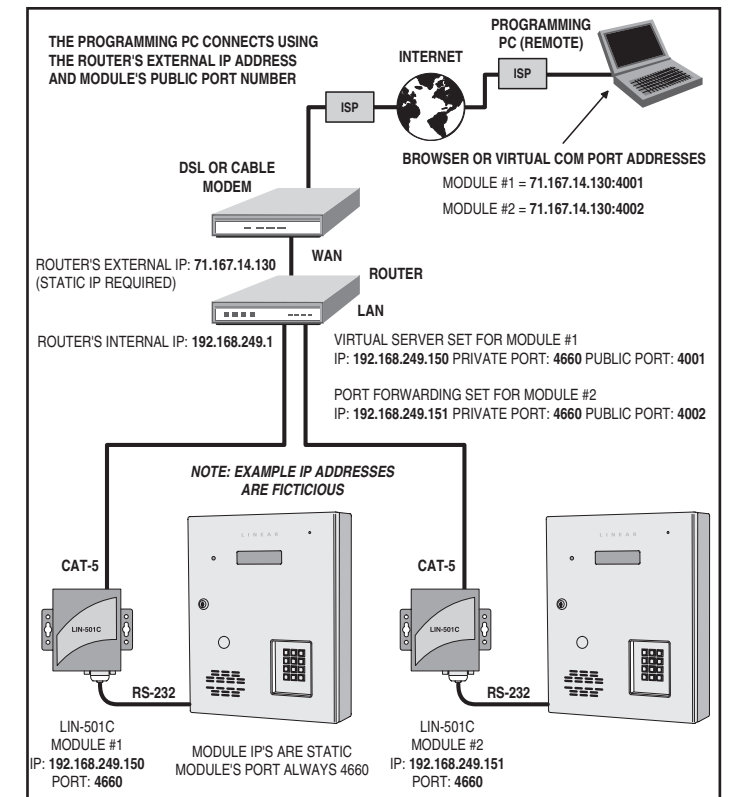

**Virtual COM Port Setup for Remote Access**

Follow these steps to setup the virtual COM ports for remote access:

1. Determine the exterior (WAN) IP address by checking the router's device information page.
2. From the Windows **START** menu, launch the Serial-IP Control Panel application.
3. In the **SERIAL/IP CONTROL PANEL** select a COM port to use to connect to a module. Be sure the **CONNECT TO SERVER** box is checked. Enter the router's **external** IP address in the **IP ADDRESS** field. Enter the module's **public** port number that was set up for the module in the virtual server into the **PORT NUMBER** field.
4. Press **CONFIGURATION WIZARD**. The Configuration window will be displayed. To test the PC's COM port serial-to-IP connection, press **START**.
5. The status area will show the progress of the test. Green check marks indicate that the connection is OK. Red check marks indicate failures in the test. If the test fails, verify the address and port settings. Press **USE SETTINGS** to exit the wizard.
6. Repeat Steps 2 through 5 for any additional LIN-501C modules in the installation.
7. When finished, press **CLOSE** to exit the **SERIAL/IP CONTROL PANEL**.

Write the settings in the log sheet to document the virtual COM port and virtual server address settings.