

PROXP-20-SW
POLARIS® RZR® PRO XP SUBWOOFER ENCLOSURE
OWNER'S MANUAL



THANK YOU

Thank you for making the AWESOME decision to purchase our MTX Audio direct-fit subwoofer enclosure designed for the Polaris® RZR® Pro XP. Our sub enclosure, with its high output 10" subwoofer, will belt out the bass and deliver ground pounding audio making you the party vehicle in any ride! With a few basic hand tools in your trusty toolbox, you can have this installed in no time. So, what are you waiting for? It's time to get the rumble in your ride and go hit the trails! Oh, and congratulations on your purchase, thanks for your support and most importantly, enjoy the ultimate audio experience with MTX!

WE'RE HERE TO HELP

We're here to help with any installation or technical support. Visit mtx.com to chat, call 1-800-225-5689 to speak with an MTX Technical Support representative, or visit youtube.com/user/MTXAudioUSA to view product videos.

DON'T FORGET TO REGISTER YOUR PRODUCT

Don't forget to register your new MTX Audio product. Visit mtx.com/productregistration or scan the QR code to the right.

Model # _____

Serial # _____

Dealer's Name _____

Date of Purchase _____



IMPORTANT NOTICE

Whenever working on the vehicle, it is recommended to disconnect the battery prior to starting work. Failure to do so may lead to a risk of electric shock or equipment damage.

When connecting power and ground wires ensure that the red power wire is fused at the point where it is connected to the vehicle's battery. Failure to do so can result in damage to the vehicle if a short circuit develops between the vehicle connection point and the product.



FEATURES

- Ported Enclosure Design Produces Louder, Deeper Bass Output
- Includes an MTX 55 Series Subwoofer for its Deep Bass Reproduction Capabilities
- Compatible with Existing OEM Front Speaker Enclosures
- Mounts Behind Dashboard
- Factory Matched Texture
- Installer Friendly Design
- Direct Fit, No Cutting or Drilling Required

SPECIFICATIONS

- 10" Loaded Subwoofer Enclosure
- RMS Power Handling: 400-Watts
- Peak Power Handling: 800-Watts
- Sensitivity (2.83V/1m): 90.2dB
- Sensitivity (1W/1m): 83.5dB
- Frequency Response: 28Hz - 130Hz
- Impedance: Dual 4Ω

FIT GUIDE

Pro XP / XP4 Sport	2021 - 2022
Pro XP / XP4 Premium	2020 - 2022
Pro XP / XP4 Ultimate	2020 - 2022
Pro XP / XP4 Sport RFLE.....	2021
Pro XP / XP4 Ultimate RFLE	2021

IN THE BOX

- PROXP-20-SW Loaded Subwoofer Enclosure
- Mounting Hardware
 - (1) Mounting Bracket
 - (3) M6 (10mm) Hex Head Bolts - 15mm Long
 - (2) T40 Torx Pan Head Bolts - 45mm Long
 - (8) Zip Ties

DISASSEMBLY

Step 1 - Start by removing the hood. Remove two (2) T-40 TORX bolts and lift off.

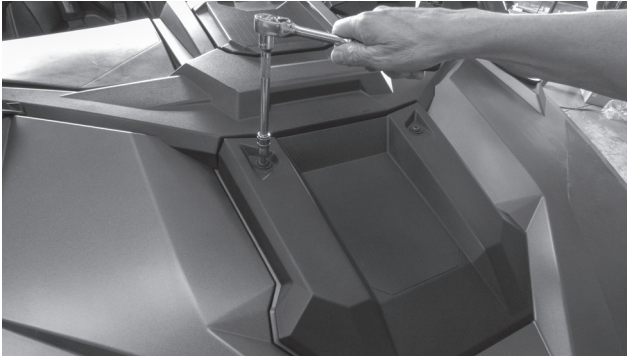

Step 2 - Remove two (2) T-40 TORX bolts located under hood securing the front of the dash.

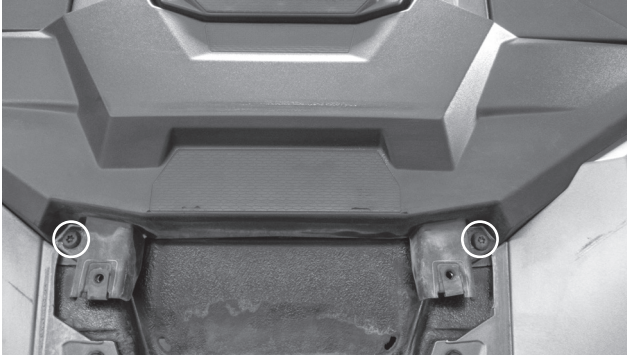

Step 3 - Remove two (2) panel clips located under the hood securing the left and right fenders.



Step 4 - Remove three (3) grey trim pieces from the front of the dash using a panel removal tool or by gently prying with a flat blade screwdriver.



One left of steering wheel



One right of steering wheel



One on passenger side

Step 5 - Remove seven (7) T-40 TORX bolts across the bottom front and top of the dash panel as indicated.

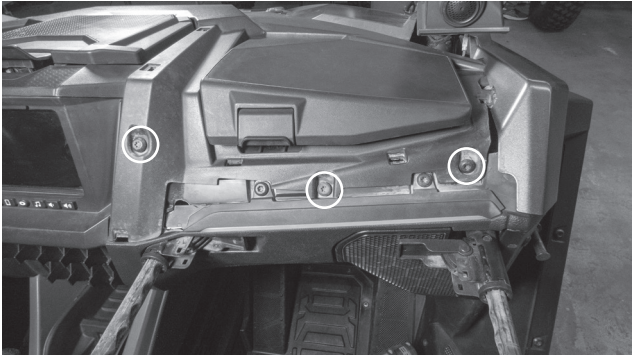
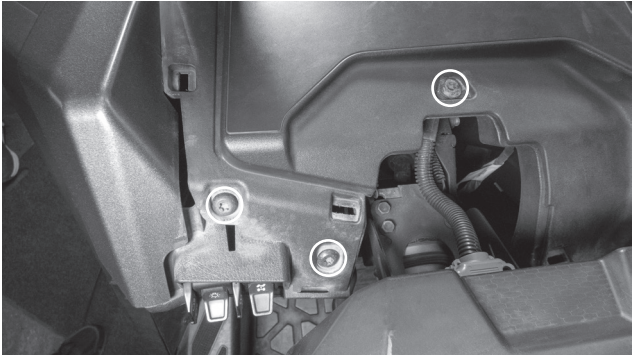

Step 6 - Remove four (4) T-20 TORX screws found under the passenger side glove box lid. This will allow the glove box to drop out from the bottom of the dash. **Note:** This pocket will not be reused with the subwoofer enclosure installation.

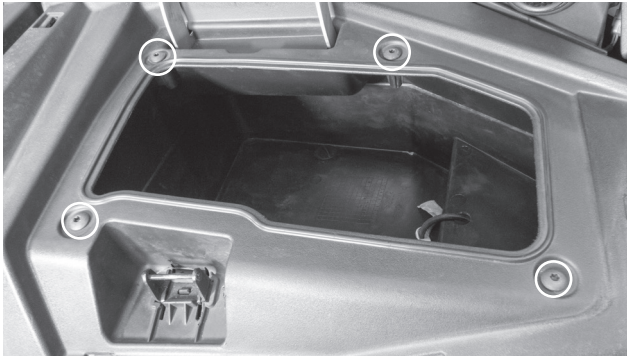

Step 7 - Open the top center storage compartment and lift out the pocket liner. Push the USB connector through the side of the pocket, freeing it and lift out of the vehicle. **Note:** This pocket will be reinstalled upon reassembly.

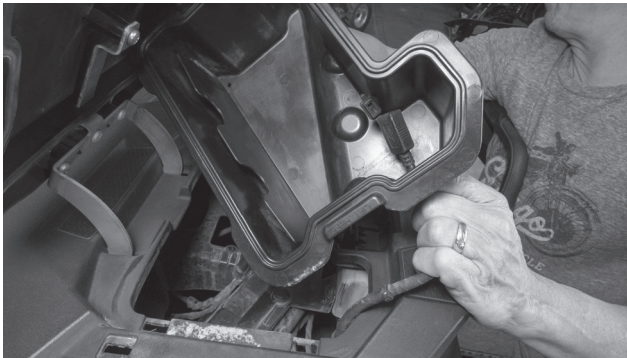

Step 8 - Disengage the tweeter housing from the top of the dash panel and slide up the cage.



Step 9 - Starting on either side, lift on the fender panel to disengage the tabs that pass through the dash panel. While lifting, slide the dash panel toward the back of the vehicle freeing it from the fender. Repeat this on the other side. Once the dash panel is free lift out of the vehicle and set aside.





Step 10 - Locate and remove the under-dash tray found below the center storage pocket location by removing five (5) panel clips and two (2) T-25 TORX screws located on the firewall below the pulse connector bank. If the vehicle has the OE audio amplifier installed, disengage its harness connector, and lift the panel out.

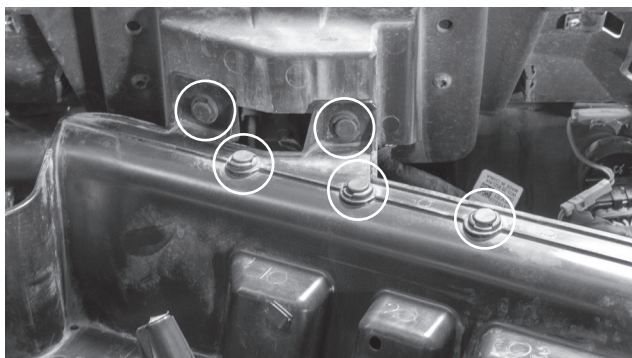
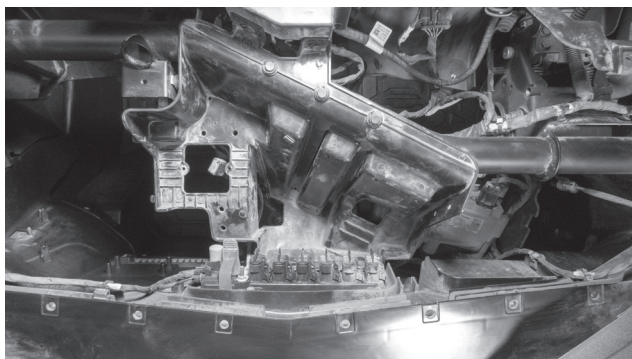

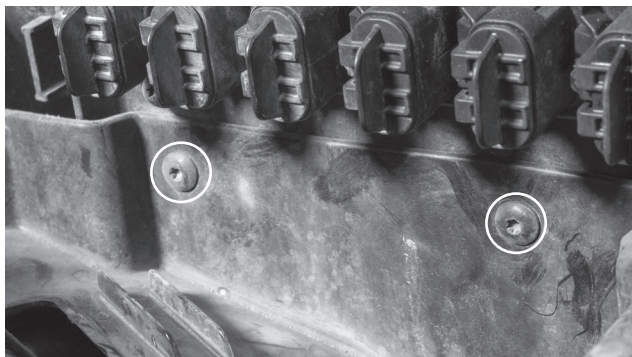

Note: If you are installing the subwoofer enclosure as part on an MTX Thunder kit, this tray will not be reused. The kit amplifier mounting rack will replace this part.



If not installing as part of an MTX Thunder kit, the tray will need to be modified as indicated prior to reinstallation. Cut and remove the area indicated.

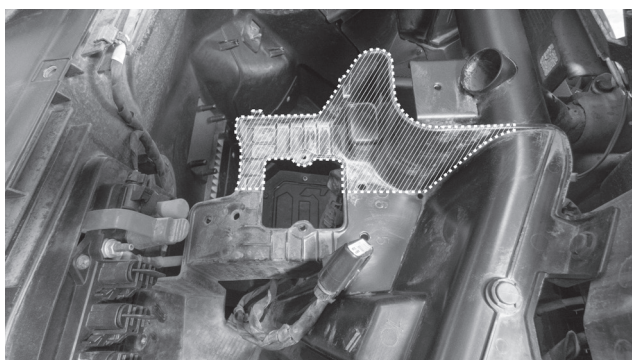

INSTALLATION

Step 11 - Start by installing two (2) brass colored speed clips into the indicated factory locations on the lower firewall in the passenger side footwell.

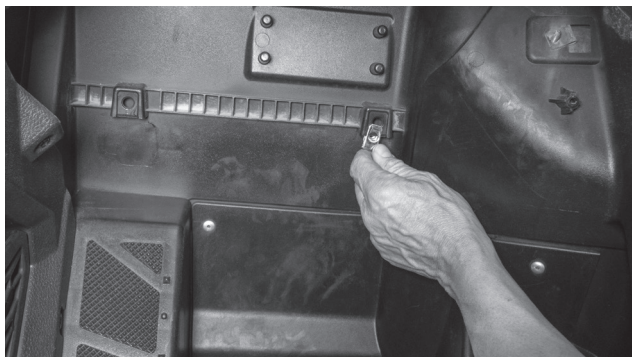

Step 12 - Locate the subwoofer mounting bracket, three (3) 10mm bolts and two (2) t-40 TORX bolts.

Step 13 - Holding the subwoofer enclosure with the MTX logo up and the woofer facing the passenger seat, install the enclosure from below by lifting and rotating the enclosure into place. The padded channel on the top of the enclosure will seat below the frame tube at the top of the dash.





Step 14 - Holding the enclosure in place, install the upper bracket in place by sliding the slots over the molded tabs at the front of the enclosure lining up the three holes with the brass inserts in the top of the enclosure.



Step 15 - Loosely install the three (3) 10mm bolts into the top of the enclosure securing the bracket in place.

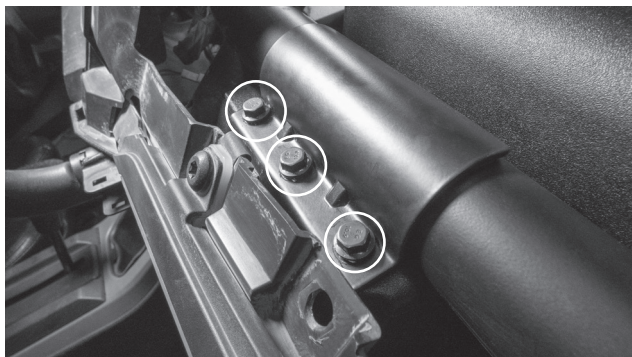

Step 16 - Pressing the bottom of the enclosure against the firewall, align the mounting holes with the previously installed speed clips. Install the two (2) T-40 TORX bolts and tighten.



Step 17 - Tighten the top bolts fully to finish securing the enclosure in place.

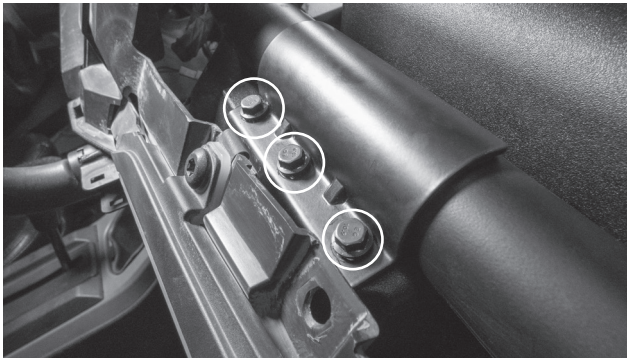

Step 18 - If not installing as part of an MTX Thunder kit, reinstall the modified under-dash tray. Reconnect the OE amplifier if disconnected previously.

Note: If installing as part of an MTX Thunder kit, plug the subwoofer enclosure into the subwoofer harness provided in the kit.

If not installing as part of an MTX Thunder kit, the enclosure will need to be hardwired by removing the connector and following the wiring diagram below.

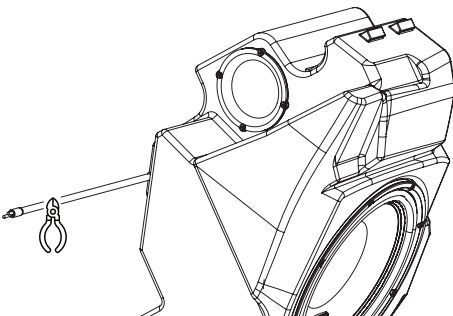

Speaker Wire
Red (+)
Black (-)

Once the subwoofer enclosure is connected test for function.

Step 19 - Reassemble and go ride.

WARRANTY PERIOD

At MTX Audio we engineer products that will stand up to the test of time. We also realize that from time to time a problem may occur. That's why our products carry a 2-year limited warranty that begins at the time of sale to the end user.

Of course, we're here to help. If you experience an issue with any of our products within the warranty period, please contact our customer service technical line at 1-800-CALL-MTX to help troubleshoot your issue. If, after speaking with our technical experts it is determined that a problem lies with the product, the technician will provide you with a Return Authorization number and all relevant details you'll need to get the product taken care of.

MITEK WARRANTY

MiTek Mobile products (including, but not limited to: MTX, Coustic, Streetwires, Xtant, BassSlammer, and Thunder Marine) purchased in the USA from an AUTHORIZED MITEK DEALER are guaranteed against defects in material and workmanship for the period of time specified. The warranty period begins the day the product is purchased by the end user, and this warranty is limited to the original retail purchaser of product. Products found to be defective during the warranty period will be repaired or replaced with equivalent product by MiTek at no charge. This warranty is void if it is determined that unauthorized parties have attempted repairs or alterations of any nature, and the warranty does not extend to cosmetics or finish. MiTek disclaims any liability for other incurred or consequential damages resulting from product defects. MiTek's total liability will not exceed the purchase price of the product.



Let's Get Social
mtx.com



Like, Follow, & Subscribe

© 2021 MiTek Corporation. All rights reserved. MTX is a trademark of MiTek Corporation. All other trademarks are property of their respective owners. Designed and Engineered in the U.S.A.

Due to continual product development, all specifications are subject to change without notice.

MTX Audio, 4545 East Baseline Rd. Phoenix, AZ 85042 U.S.A. 1-800-225-5689

MTX006857 RevA 12/21 • AW0016030 • 1-14928