

# SONANCE ARCHITECTURAL SERIES®

## DISCREET OPENING SYSTEM



### Award Winning Architectural Series Aesthetic and Best-in-class Sonic Performance

The Discreet Opening System is the latest evolution in the Sonance Architectural Series. Using state-of-the-art materials, the unique satellite and subwoofer system envelops a space with amazing sound and perfectly even coverage delivering

superior performance to traditional loudspeakers. Featuring a trim-less design and completely flush aesthetic, it matches the footprint of small aperture downlights and complements any architectural style.

### Features and Benefits

- Unique satellite speaker and subwoofer system that immerses a space with perfectly even volume coverage, eliminating areas that are too loud or too quiet
- Discreet opening system delivers the ultimate combination of amazing sonic performance with minimal visual impact
- Totally flush aesthetic that perfectly matches trim-less downlights in shape and dimension; resulting in continuous sight lines and zero shadow lines
- State-of-the-art driver materials combined with cutting-edge design technology ensures clean and accurate tonality and smooth powerful bass response
- TRUFIG-inspired mounting platform with precision grille leveling; delivers a high-quality, repeatable installation process in drywall, plaster, wood, and other solid surfaces
- Mounting platform design provides greater positioning flexibility, allowing accurate alignment and spacing with down lights



### Specifications

#### AS38RS Speaker

Diameter: 3 7/8" (99mm)  
Depth: 3 1/2" (89mm)

#### AS38RS Round Grille

Diameter: 4" (102mm)

#### AS38RS Square Grille

Width x Height: 4" x 4"  
(102mm x 102mm)

\*Round & square grille included with speaker

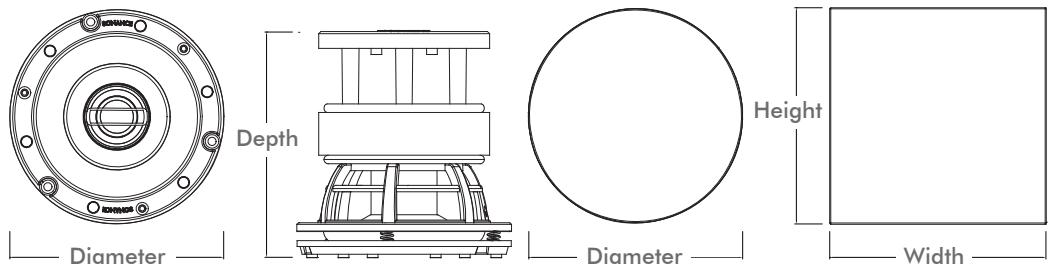

#### BPS6 Subwoofer

Height: 7 7/8" (200mm)  
Width: 15 3/4" (400mm)  
Depth: 11 15/16" (303mm)

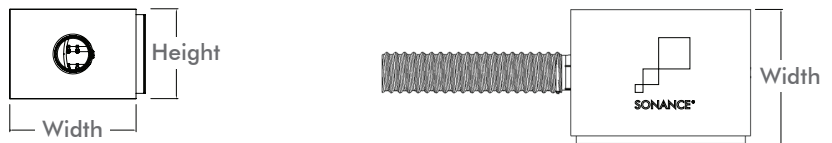

#### BPS6 Port Tube

Diameter: 3" (76mm)  
Length: 22" (559mm)

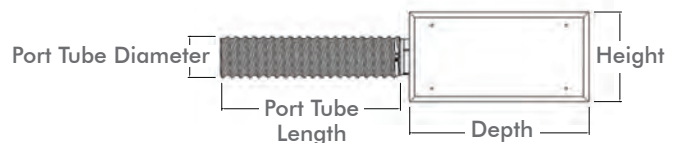

## Specifications

### ASBPC3RS

Diameter: 3 7/8" (99mm)  
 Depth: 2 1/4" (57mm)

### AS38RS Round Grille

Diameter: 4" (102mm)

### AS38RS Square Grille

Width x Height: 4" x 4"  
 (102mm x 102mm)

\*Round & square grille included with coupler

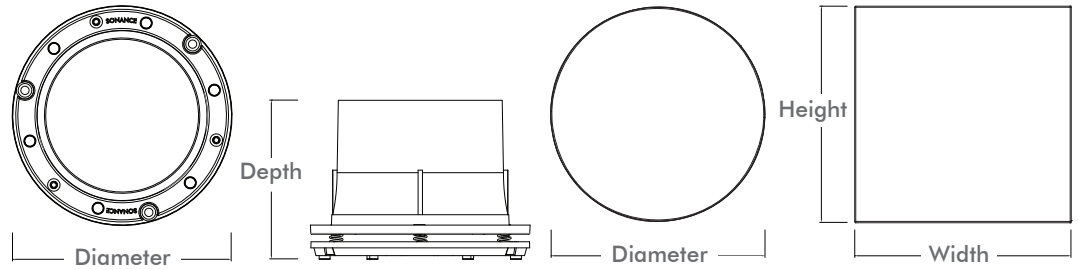

## Discreet Opening System - Mounting Platform Specifications

### 1/2" Gypsum Mounting Platform AS Discreet Round

### 5/8" Gypsum Mounting Platform AS Discreet Round

Height: 12" (305mm)  
 Width: 31 7/8" (810mm)  
 Depth: 1 15/32" (38mm)

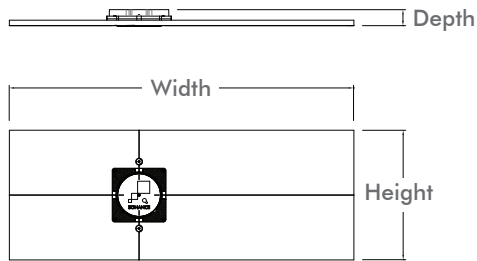

### 1/2" Gypsum Mounting Platform AS Discreet Square

### 5/8" Gypsum Mounting Platform AS Discreet Square

Height: 12" (305mm)  
 Width: 31 7/8" (810mm)  
 Depth: 1 15/32" (38mm)

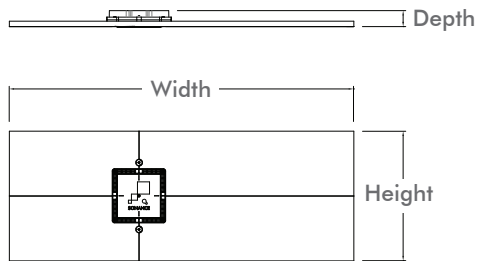

### 5/8" Solid Surface Mounting Platform AS Discreet Round/Square

Height: 12" (305mm)  
 Width: 31 7/8" (810mm)  
 Depth: 1 7/16" (37mm)

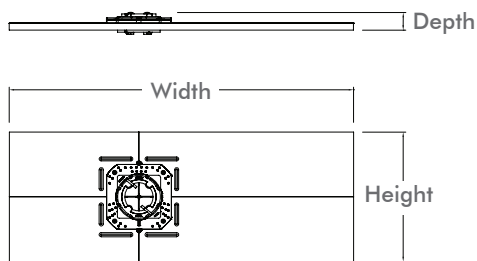

### Solid Surface Router Template AS Discreet Round/Square

Height: 13" (330mm)  
 Width: 19" (483mm)  
 Round Template: 4 5/32" (106mm)\*  
 Square Template: 4 3/16" (107mm)\* x  
 4 3/16" (107mm)\*

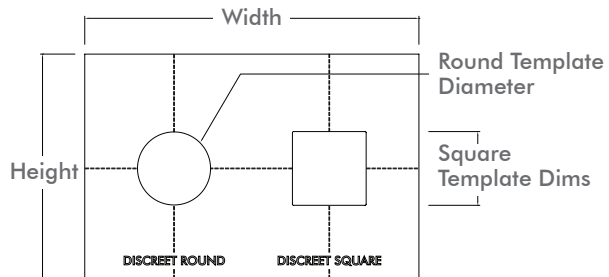

\*WARNING: Opening is NOT actual size of installed product. Must be used with router bushings and bit specified on actual router template.

\*\*See detailed instructions in manual at [www.sonance.com/in-wall-in-ceiling/architectural-series](http://www.sonance.com/in-wall-in-ceiling/architectural-series)

## Discreet Opening System Wiring Option 4.1

AS System Wiring Diagram – 2 channel amplifier

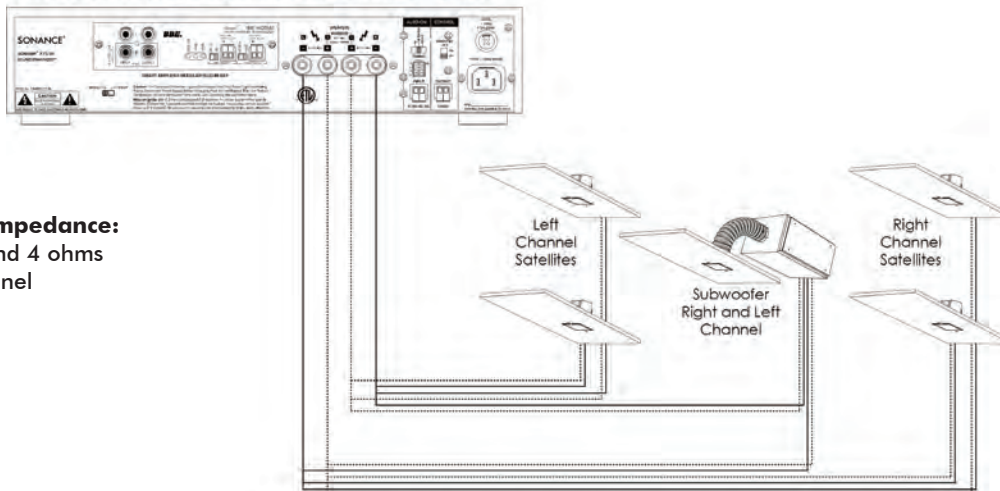

**AS38RS System Impedance:**  
6 ohms nominal and 4 ohms  
minimum per channel

**Home Run Wire To Each Speaker!**

## Discreet Opening System Wiring Option 4.2

AS System Wiring Diagram – 2 channel amplifier

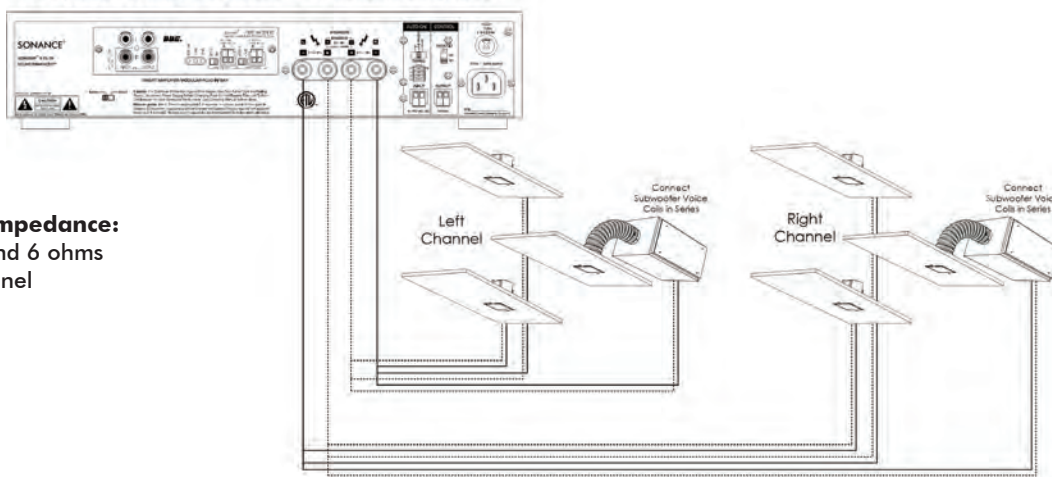

**AS38RS System Impedance:**  
8 ohms nominal and 6 ohms  
minimum per channel

**Home Run Wire To Each Speaker!**

## Discreet Opening System Wiring Option 4.1 with Subwoofer on Separate Channel

AS System Wiring Diagram – 8 channel amplifier

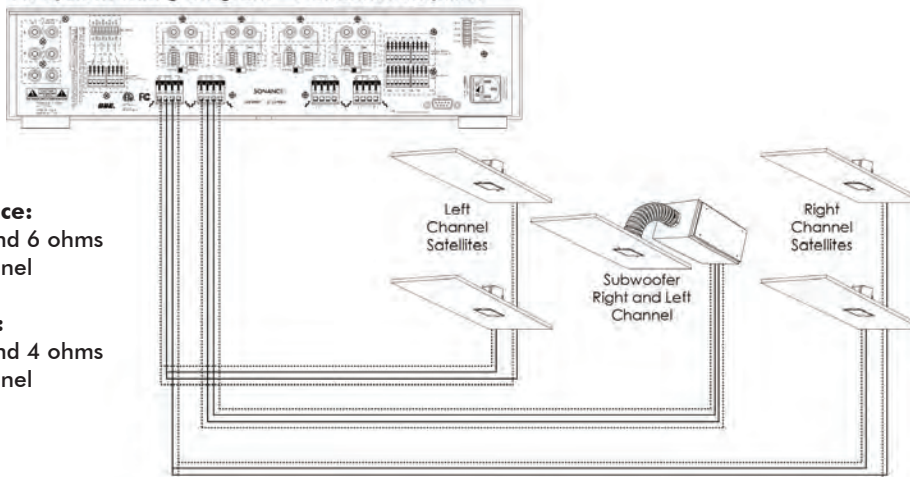

**AS38RS Impedance:**  
8 ohms nominal and 6 ohms  
minimum per channel

**BPS6 Impedance:**  
6 ohms nominal and 4 ohms  
minimum per channel

**Home Run Wire To Each Speaker!**



### SPECIFICATIONS

### AS38RS

SKU	93041
UOM	Each
Tweeter	3/4" (19mm) ceramic dome, Ferrofluid-cooled, in acoustic back chamber
Woofer	3 1/2" (89mm) carbon fiber / Rohacell laminated cone with a rubber surround
Frequency Response	75Hz – 20kHz ± 3dB
Impedance	10 ohms nominal; 8 ohms minimum
Power Handling	100 watts maximum
Sensitivity	83dB SPL (2.83V/1 meter)
Grille	Shipped w/ Round 4" (102mm) and Square 4" (102mm) perforated steel grilles
High Pass Filter	125Hz 6dB per Octave
Dimensions (Dia. x D)	3 7/8" x 3 1/2" (99mm x 89mm)
Shipping Weight	3 lbs (1.4kg) each



### SPECIFICATIONS

### BPS6

SKU	93043
UOM	Each
Woofer	6 1/2" (165mm) dual voice coil, carbon fiber / Rohacell laminated cone with a rubber surround
Frequency Response	40Hz – 125Hz ± 3dB
Impedance	6 ohms nominal; 4 ohms minimum
Power Handling	100 watts maximum
Sensitivity	87dB SPL (2.83V/1 meter)
Dimensions Sub (H x W x D)	7 7/8" x 11 15/16" x 15 3/4" (200mm x 303mm x 400mm)
Dimensions Port Tube (Dia. x Length)	3" x 22" (76mm x 559mm)
Shipping Weight	15 lbs (6.9kg) each



### SPECIFICATIONS

### ASBPC3RS

SKU	93073
UOM	Each
Grille	Shipped w/ Round 4" (102mm) and Square 4" (102mm) perforated steel grilles
Dimensions (Dia. x D)	3 7/8" X 2 1/4" (99mm x 57mm)
Shipping Weight	1 lbs (.47kg) each

## Architectural Series Associated Products

1/2" Gypsum Mounting Platform  
AS Discreet Round 93045  (Each)

5/8" Gypsum Mounting Platform  
AS Discreet Round 93047  (Each)

5/8" Solid Surface Mounting Platform  
AS Discreet RS 93053  (Each)

1/2" Gypsum Mounting Platform  
AS Discreet Square 93046  (Each)

5/8" Gypsum Mounting Platform  
AS Discreet Square 93048  (Each)

Solid Surface Router Template  
AS Discreet RS 93057  (Pair)

Small Retrofit Enclosure 92443  (Pair)

Sonamp 875D MKII Amp. (120V) 92804  (Each)

Sonamp 275 SE Amp. (120V) 92187  (Each)

Sonamp 2120T MKII Amp. (120V) 91122  (Each)

Sonamp 875D MKII Amp. (230V) 92805  (Each)

Sonamp 275 SE Amp. (230V) 92191  (Each)

Sonamp 2120T MKII Amp. (230V) 91602  (Each)

### LIMITED LIFETIME WARRANTY

Sonance warrants to the first end-user purchaser that this Sonance-brand product ("Product"), when purchased from an authorized Sonance Dealer/Distributor, will be free from defective workmanship and materials for the life of the Product, except for the grille, which is warranted for five (5) years. Sonance will at its option and expense either repair the defect or replace the Product with a new or remanufactured Product or a reasonable equivalent. **Please visit our website and owner's e-Manual for complete warranty and exclusion information.**



©2014 Sonance. All rights reserved.

Sonance and Architectural Series are registered trademarks of Dana Innovations.

Due to continuous product improvement, all features and specifications are subject to change without notice.

For the latest Sonance product specification information visit our website: [www.sonance.com](http://www.sonance.com)

SONANCE • 212 Avenida Fabricante • San Clemente, CA 92672-7531 USA

(800) 582-7777 or (949) 492-7777 • FAX: (949) 361-5151 • Technical Support: (800) 582-0772

[www.sonance.com](http://www.sonance.com)