



SM-EZ Series

Install Instructions For:

SM52-EZ-BK, SM52-EZ-WH, SM52-EZ-WX-BK, SM52-EZ-WX-WH,
SM82-EZ-BK, SM82-EZ-WH, SM82-EZ-WX-BK & SM82-EZ-WX-WH

Box contents

- 1 Speaker
- 1 U-bracket
- 2 U-bracket screws
- 2 Screw caps
- 1 Allen wrench
- 1 Back plate
- 1 Port plug
- 1 Safety cable
- 1 Strain relief bushing

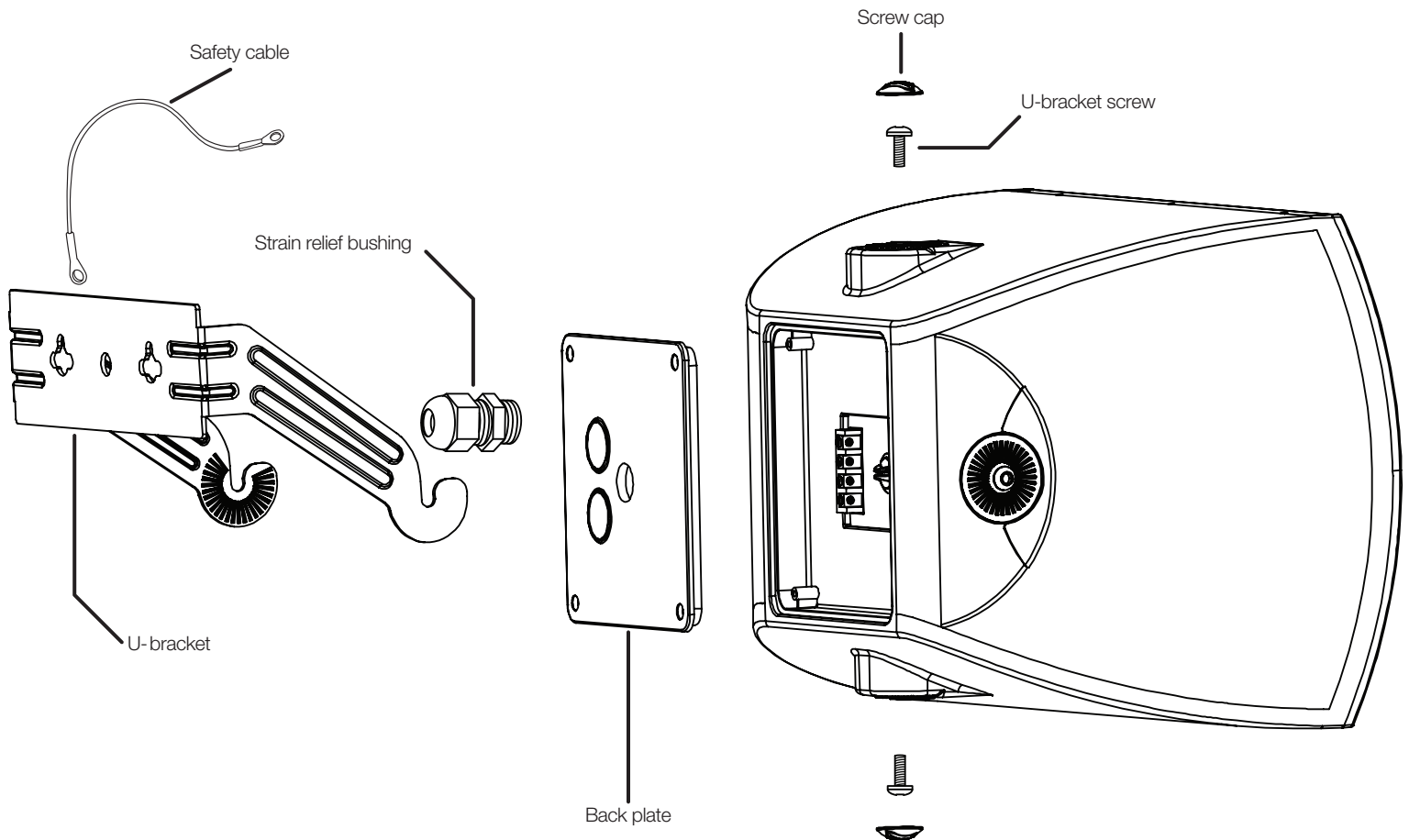

1.435.647.9555 | 800.647.TUBE | www.soundtube.com

©2016 SoundTube Entertainment, Inc. All rights reserved. PN INS-SM-EZ Rev02-10-2016

Warning

SoundTube speakers must be installed by a professional audio installer/contractor. For safety and for optimum audio performance, installer must follow all directions issued by SoundTube Entertainment.

Warning

Do not spec or install speaker near support beam, ventilation duct or other structure that may interfere with speaker function or dispersion.

SM-EZ Series

Install Instructions For:

SM52-EZ-BK, SM52-EZ-WH, SM52-EZ-WX-BK, SM52-EZ-WX-WH,
SM82-EZ-BK, SM82-EZ-WH, SM82-EZ-WX-BK & SM82-EZ-WX-WH

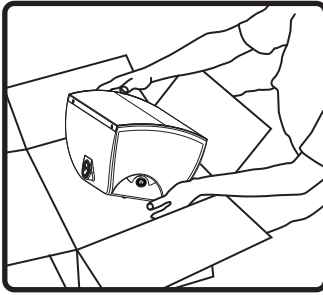

1. Unpack speaker and mounting hardware.

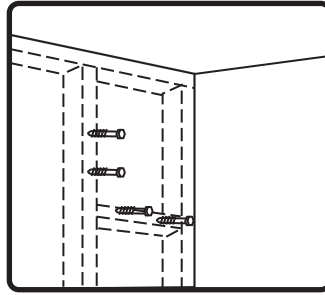

2. Choose a secure mounting surface with sufficient strength to reliably hold the speaker. The speaker may be mounted in either the vertical or the horizontal position with the same U-bracket.

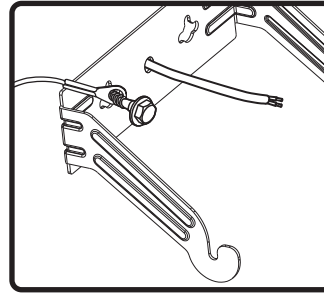

3. Mount u-bracket with clamping slots pointing upward. Securely fasten mounting bracket and safety cable to surface (user must supply fasteners).
Note: The safety cable will attach to the U-bracket clamping screw on one side of the cabinet.

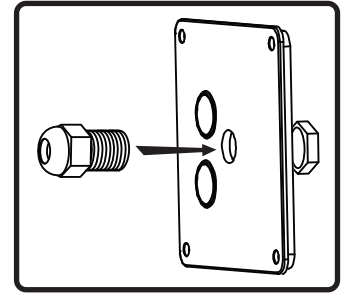

4. If being installed per EN54-24 regulations or in instances where a water tight strain relief bushing is necessary, attach the included strain relief bushing to the back plate. If it is not required, skip this step.

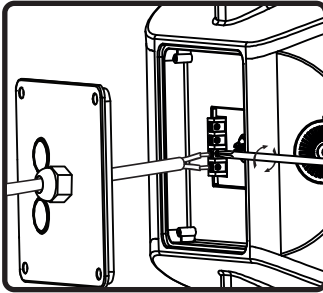

5. Run signal wires through strain relief bushing then connect to ceramic terminal strip. Two + (plus) and two - (negative) connectors are provided for daisy chaining.

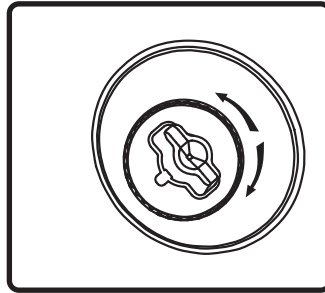

6. Select the tap position by rotating the rotary switch located on the back of the speaker to desired setting. The switch is preset to the maximum tap setting in 70.7 V mode (32W for the SM52-EZ[-WX] and 64W for the SM-82-EZ-II[-WX]).

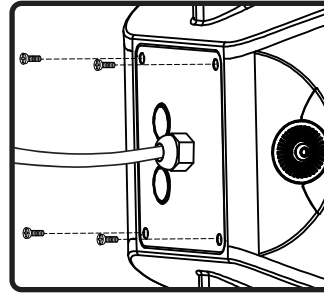

7. Install back plate and secure with included fasteners.

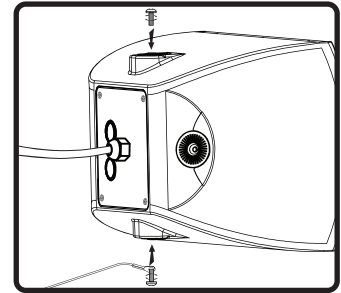

8. Select desired location for safety cable and remove the U-bracket screw from that side. Attach safety cable to the clamping screw and reinstall loosely.

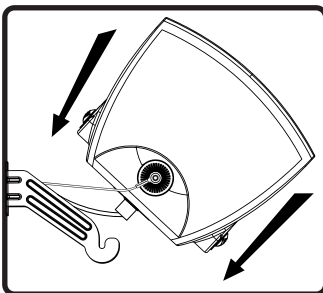

9. Tilt speaker 45° (grille up) and slide on to bracket.

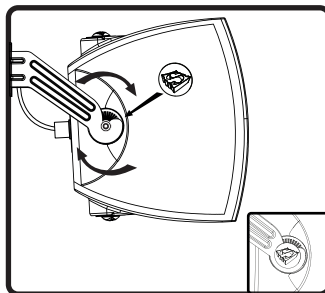

10. Aim speaker and tighten u-bracket screws. Once tightened down, place the screw caps on the screws. Done!

Port protection for SM-EZ

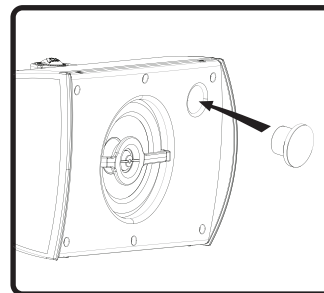

To enhance protection of internal components from humidity and other potentially corrosive elements, use provided port plug to seal enclosure. Use RTV silicone around edge of the port plug for increased protection. **Note:** WX versions will come with the port plug pre-installed.



SM82-EZ-WX, SM52-WX

Install Instructions For:
Stainless Steel Bracket and Port Plug Installation

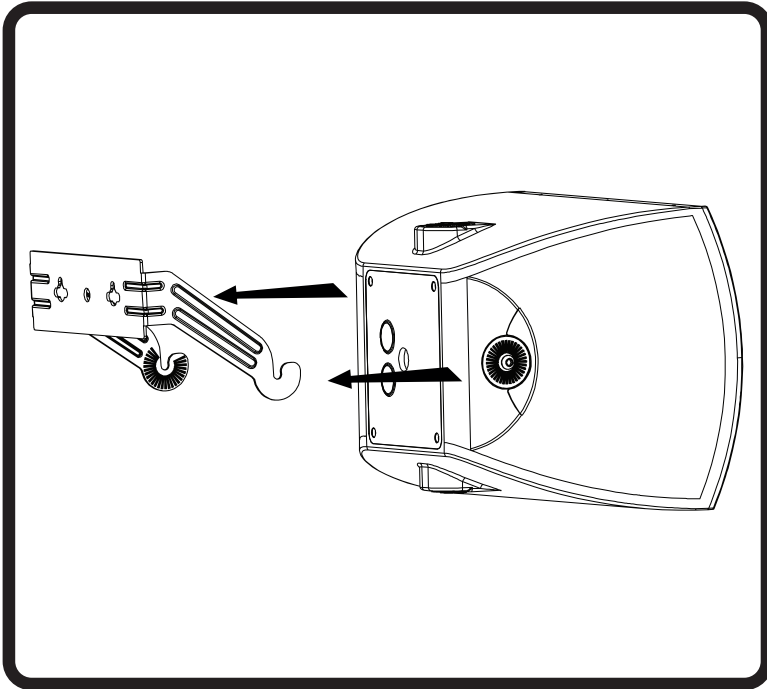

1. To make this unit weather extreme rated (WX) you will need to locate and discard the bracket that came in the box with the loudspeaker. WX units come with a separate stainless steel mounting bracket that will be used instead.

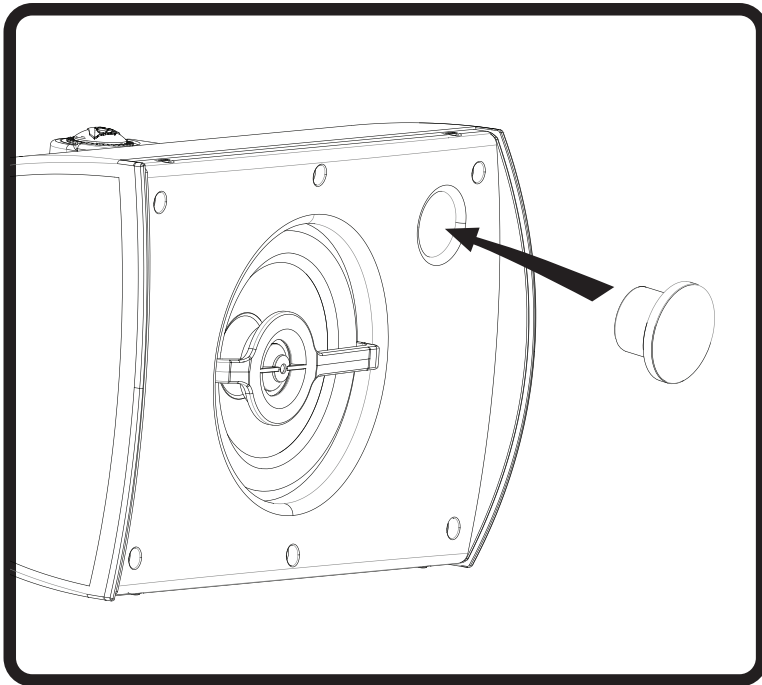

2. To make this unit weather extreme rated (WX) the port plug supplied in the box will need to be installed. Remove the grill by taking out the screws located around the edges. The grill should come off easily. Push port plug into hole on baffle and re-install grill. Note: RTV silicone can be used on the port plug for increased protection.

Warning

SoundTube speakers must be installed by a professional audio installer/contractor. For safety and for optimum audio performance, installer must follow all directions issued by SoundTube Entertainment.

Warning

Do not spec or install speaker near support beam, ventilation duct or other structure that may interfere with speaker function or dispersion.